

# PVL Inline Valves

Catalogue No.

GB-ca



- High flow, compact size
- Push-in or threaded connection
- DIN rail or block mounting
- Light weight construction
- Inline stand alone or stackable version
- Available in 2 x 3/2 - 5/3 (PVL-B/C)

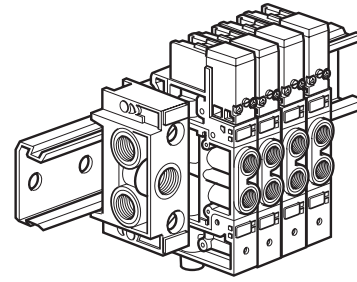





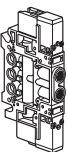

## Operating information

Working pressure:								
Pneumatically operated:	2-10 bar		Flow:	Qmax	<b>PVL-A</b>	<b>PVL-B</b>	<b>PVL-C</b>	
Electrically operated, bistable:	2-10 bar		(acc. to ISO 6358)		270	900	1800	NI/mn
Electrically operated, monostable:	3-10 bar		Flow measured with valve on manifold					
Working temperature	-15 °C to +60 °C							

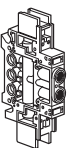
## Main data for PVL-A directional control valves

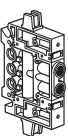
### Stackable version

Symbol	Connec-Actuator tion	Return	Signal pressure min, bar at 6 bar actua./return	Changeover time, ms at 6 bar actua./return	Weight Kg	Order code	D
<b>Electrically actuated 5/2 valves</b>							
Complete with 0,9 W 24 VDC, miniature solenoid, LED indication and Plug-in connector with 2 m cable							
	Ø4 mm Electric	Electric	1,0/1,0	12/12	0,070	<b>PVL-A122304B40</b>	1
	M5		1,0/1,0	12/12	0,070	<b>PVL-A122315B40</b>	1
	Ø4 mm Electric	Spring	2,2/1,2	12/24	0,060	<b>PVL-A121304B50</b>	1
	M5		2,2/1,2	12/24	0,060	<b>PVL-A121315B50</b>	1
<b>Without miniature solenoid actuator</b>							
	Ø4 mm Electric	Electric	1,0/1,0	12/12	0,070	<b>PVL-A122304</b>	3
	M5		1,0/1,0	12/12	0,070	<b>PVL-A122315</b>	3
	Ø4 mm Electric	Spring	2,2/1,2	12/24	0,060	<b>PVL-A121304</b>	3
	M5		2,2/1,2	12/24	0,060	<b>PVL-A121315</b>	3
<b>Pneumatically actuated 5/2 valves</b>							
	Ø4 mm Air	Air	1,0/1,0	10/10	0,070	<b>PVL-A122104</b>	1
	M5		1,0/1,0	10/10	0,070	<b>PVL-A122115</b>	1
	Ø4 mm Air	Spring	2,2/1,2	10/22	0,060	<b>PVL-A121104</b>	1
	M5		2,2/1,2	10/22	0,060	<b>PVL-A121115</b>	1

\* Each valve is supplied with two tie rods for use in the "stacking" system

## Main data for PVL-B/C directional control valves

### Stackable version

Symbol	Connec-Actuator tion	Return	Signal pressure min, bar at 6 bar actua./return	Changeover time, ms at 6 bar actua./return	Weight Kg	Order code	D
--------	-------------------------	--------	--	---	--------------	------------	---

### Electrically/pneumatically actuated 5/2 valves

#### Size G1/8

For use with 1,2 W / 1,6 VA miniature solenoid actuator or air-pilot connector

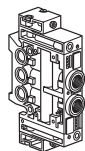

	Ø6 mm	Electric	Electric	0,7/0,7	12/12	0,120	<b>PVL-B122606</b>	1
	G1/8	or Air	or Air	0,7/0,7	12/12	0,120	<b>PVL-B122618</b>	1
	Ø6 mm	Electric	Spring	2,8/1,2	15/30	0,125	<b>PVL-B121606</b>	1
	G1/8	or Air		2,8/1,2	15/30	0,125	<b>PVL-B121618</b>	1
	Ø6 mm	Electric	Air-spring	3,7/2,1	20/25	0,125	<b>PVL-B123606</b>	3
	G1/8	or Air		3,7/2,1	20/25	0,125	<b>PVL-B123618</b>	3

### Electrically actuated 5/3 valves

Ø6 mm	Electric	Electric				0,130	<b>PVL-B127606</b>	3
G1/8	Closed centre	Self centering				0,130	<b>PVL-B127618</b>	3
Ø6 mm	Electric	Electric				0,130	<b>PVL-B128606</b>	3
G1/8	Vented centre	Self centering				0,130	<b>PVL-B128618</b>	3

### Electrically/pneumatically actuated 2 x 3/2 valves

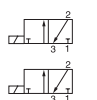
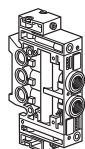

Ø6 mm	Electric or Air	Electric or Air	2,3/4,5	7/15		0,130	<b>PVL-B125606</b>	1
G1/8	Electric or Air	Electric or Air	2,3/4,5	7/15		0,130	<b>PVL-B125618</b>	1

### Electrically/pneumatically actuated 5/2 valves

#### Size G1/4

For use with 1,2 W / 1,6 VA miniature solenoid actuator or air-pilot connector

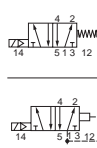
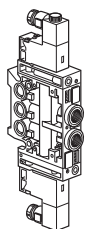

Ø8 mm	Electric	Electric	0,9/0,9	17/17		0,230	<b>PVL-C122608</b>	1
G1/4	or	or	0,9/0,9	17/17		0,230	<b>PVL-C122619</b>	3
G3/8	Air	Air	0,9/0,9	17/17		0,230	<b>PVL-C122613</b>	3
Ø8 mm	Electric	Spring	2,8/1,0	25/60		0,240	<b>PVL-C121608</b>	1
G1/4	or		2,8/1,0	25/60		0,240	<b>PVL-C121619</b>	1
G3/8	Air		2,8/1,0	25/60		0,240	<b>PVL-C121613</b>	1
Ø8 mm	Electric	Air-spring	3,5/2,3	30/50		0,240	<b>PVL-C123608</b>	3
G1/4	or		3,5/2,3	30/50		0,240	<b>PVL-C123619</b>	3
G3/8	Air		3,5/2,3	30/50		0,240	<b>PVL-C123613</b>	3

### Electrically actuated 5/3 valves

Ø8 mm	Electric	Electric				0,250	<b>PVL-C127606</b>	3
G1/4	Closed centre	Self centering				0,250	<b>PVL-C127618</b>	3
Ø8 mm	Electric	Electric				0,250	<b>PVL-C128606</b>	3
G1/4	Vented centre	Self centering				0,250	<b>PVL-C128618</b>	3

#### Size G1/4

For use with 6 W / 8,5 VA solenoid actuator or air-pilot connector

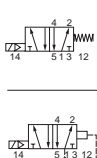
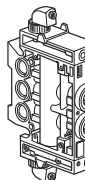

Ø8 mm	Electric	Electric	0,9/0,9	15/15		0,240	<b>PVL-C122408</b>	3
G1/4	or	or	0,9/0,9	15/15		0,240	<b>PVL-C122419</b>	3
	Air	Air						
Ø8 mm	Electric	Spring	2,8/1,0	20/50		0,250	<b>PVL-C121408</b>	1
G1/4	or		2,8/1,0	20/50		0,250	<b>PVL-C121419</b>	1
	Air							
Ø8 mm	Electric	Air-spring	3,5/2,3	25/45		0,250	<b>PVL-C123408</b>	3
G1/4	or		3,5/2,3	25/45		0,250	<b>PVL-C123419</b>	3
	Air							







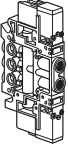
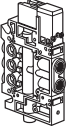

\* Each valve is supplied with two tie rods for use in the "stacking" system

\*\* The above valve operation can be either:

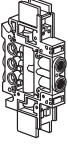
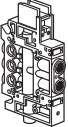
- Pneumatic, with the addition of one or two pilot connectors complete with Ø4 mm Push-in connections
- Electrical, with the addition of one or two 1 W solenoid (PVL-B), 1 W or 5 W solenoids (PVL-C)

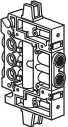
## Main data for PVL-A directional control valves

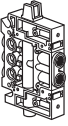
### Stand alone version

	Symbol	Connec-Actuator tion Push-in/ Threaded	Return	Signal pressure min, bar at 6 bar actua./return	Changeover time, ms at 6 bar actua./return	Weight Kg	Order code	D
<b>Electrically actuated 5/2 valves</b>								
Complete unit 0,9 W 24 VDC miniature solenoid, LED indication and plug-in connector with 2 m cable								
		Ø4 mm Electric M5	Electric	1,0/1,0 1,0/1,0	12/12 12/12	0,070 0,070	<b>PVL-A112304B40</b> <b>PVL-A112315B40</b>	3 3
		Ø4 mm Electric M5	Spring	2,2/2,2 2,2/2,2	12/24 12/24	0,060 0,060	<b>PVL-A111304B50</b> <b>PVL-A111315B50</b>	1 3
Without miniature solenoid actuator								
		Ø4 mm Electric M5	Electric	1,0/1,0 1,0/1,0	12/12 12/12	0,070 0,070	<b>PVL-A112304</b> <b>PVL-A112315</b>	3 3
		Ø4 mm Electric M5	Spring	2,2/1,2 2,2/1,2	12/24 12/24	0,060 0,060	<b>PVL-A111304</b> <b>PVL-A111315</b>	3 3
<b>Pneumatically actuated 5/2 valves</b>								
		Ø4 mm Air M5	Air	1,0/1,0 1,0/1,0	10/10 10/10	0,070 0,070	<b>PVL-A112104</b> <b>PVL-A112115</b>	3 3
		Ø4 mm Air M5	Spring	2,2/1,0 2,2/1,0	10/22 10/22	0,060 0,060	<b>PVL-A111104</b> <b>PVL-A111115</b>	3 3

## Mounting

The valves have integral mounting holes suitable for M4 screws and can be directly mounted on to any suitable surface. The pipework connections will be either use of threaded fittings or direct Push-in depending on the body selected.

## Main data for PVL-B/C directional control valves

## Stand alone version

Symbol	Conne-Actuator tion	Return	Signal pressure min, bar at 6 bar actua./return	Changeover time, ms at 6 bar actua./return	Weight Kg	Order code	D
--------	------------------------	--------	--	---	--------------	------------	---

## Electrically/pneumatically actuated 5/2 valves

## Size G1/8

For use with 1,2 W / 1,6 VA miniature solenoid actuator or air-pilot connector

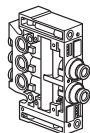

	Ø6 mm Electric	Electric	0,7/0,7	12/12	0,120	<b>PVL-B112606</b>	1
	G1/8 or Air	or Air	0,7/0,7	12/12	0,120	<b>PVL-B112618</b>	1
	Ø6 mm Electric	Spring	2,8/1,2	15/30	0,125	<b>PVL-B111606</b>	1
	G1/8 or Air	or Air	2,8/1,2	15/30	0,125	<b>PVL-B111618</b>	1
	Ø6 mm Electric	Air spring	3,7/2,1	20/35	0,125	<b>PVL-B113606</b>	3
	G1/8 or Air	or Air	3,7/2,1	20/35	0,125	<b>PVL-B113618</b>	3

## Electrically actuated 5/3 valves

Ø6 mm Electric	Electric	Electric			0,130	<b>PVL-B117606</b>	3
G1/8 Closed centre	Closed centre	Self centering			0,130	<b>PVL-B117618</b>	3
Ø6 mm Electric	Electric	Electric			0,130	<b>PVL-B118606</b>	3
G1/8 Vented centre	Vented centre	Self centering			0,130	<b>PVL-B118618</b>	3

## Electrically/pneumatically actuated 2 x 3/2 valves

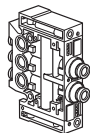

	Ø6 mm Electric	Internal air	2,3/4,5	7/15	0,130	<b>PVL-B115606</b>	3
	or Air	or Air					
	G1/8 Electric	Internal air	2,3/4,5	7/15	0,130	<b>PVL-B115618</b>	3
	or Air	or Air					

## Size G1/4

For use with 1,2 W / 1,6 VA miniature solenoid actuator or air-pilot connector

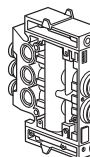

	Ø8 mm Electric	Electric	0,9/0,9	17/17	0,230	<b>PVL-C112608</b>	3
	G1/4 or	or	0,9/0,9	17/17	0,230	<b>PVL-C112619</b>	3
	G3/8 Air	Air	0,9/0,9	17/17	0,230	<b>PVL-C112613</b>	3
	Ø8 mm Electric	Spring	2,8/1,0	25/60	0,240	<b>PVL-C111608</b>	1
	G1/4 or	or	2,8/1,0	25/60	0,240	<b>PVL-C111619</b>	3
	G3/8 Air	Air	2,8/1,0	25/60	0,240	<b>PVL-C111613</b>	3
	Ø8 mm Electric	Air spring	3,5/2,3	30/50	0,240	<b>PVL-C113608</b>	3
	G1/4 or	or	3,5/2,3	30/50	0,240	<b>PVL-C113619</b>	3
	G3/8 Air	Air	3,5/2,3	30/50	0,240	<b>PVL-C113613</b>	3

## Electrically actuated 5/3 valves

Ø8 mm Electric	Electric	Electric			0,250	<b>PVL-C117608</b>	3
G1/4 Closed centre	Closed centre	Self centering			0,250	<b>PVL-C117619</b>	3
Ø8 mm Electric	Electric	Electric			0,250	<b>PVL-C118608</b>	3
G1/4 Vented centre	Vented centre	Self centering			0,250	<b>PVL-C118619</b>	3

## Size G1/4

For use with 6 W / 8,5 VA solenoid actuator or air-pilot connector

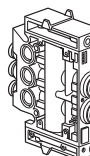

	Ø8 mm Electric	Electric	0,9/0,9	15/15	0,240	<b>PVL-C112408</b>	3
	G1/4 or Air	or Air	0,9/0,9	15/15	0,240	<b>PVL-C112419</b>	3
	Ø8 mm Electric	Spring	2,8/1,0	20/50	0,250	<b>PVL-C111408</b>	3
	G1/4 or Air	or Air	2,8/1,0	20/50	0,250	<b>PVL-C111419</b>	3
	Ø8 mm Electric	Air spring	3,5/2,3	25/45	0,250	<b>PVL-C113408</b>	3
	G1/4 or Air	or Air	3,5/2,3	25/45	0,250	<b>PVL-C113419</b>	3

The above valve operation can be either:

- Pneumatic, with the addition of one or two pilot connectors complete with Ø4 mm Push-in connections
- Electrical, with the addition of one or two 1 W or 5W solenoid actuators

## Mounting

The valves have integral mounting holes suitable for M4 screws and can be directly mounted onto any suitable surface. The pipework connections will be either use of threaded fittings or direct Push-in depending on the body selected.

## Modular piloting system

M5, G1/8 and G1/4 sizes

**Basic component**  
PVL-A1\*\*3\*\*

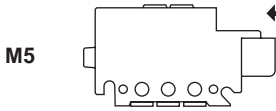

M5

Electrically actuated

**Pneumatic piloting connectors**

**Solenoid actuators**

PVA-J\*\*\*



- Power 0,9 W

PVL-A1\*\*1\*\*

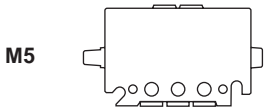

M5

Pneumatically actuated

Integral Ø4 mm  
Push-in connection

PVL-B1\*\*6\*\*

G1/8

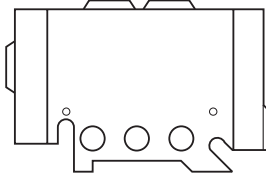

or

PVL-C1\*\*6\*\*

G1/4

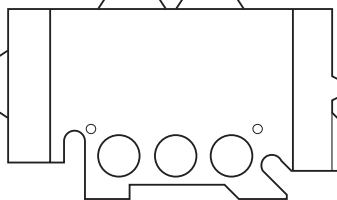

or

PVA-H249\*\*

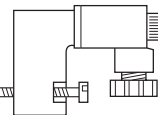

- Power: 1,2 W 1,6 VA ~

- Electrical connector: 15x15 mm

- Optional suppressor and indicator PS1-E1\*\*

Ø4 mm Push-in  
connection  
PVA-P11•



PVL-C1\*\*4\*\*

G1/4

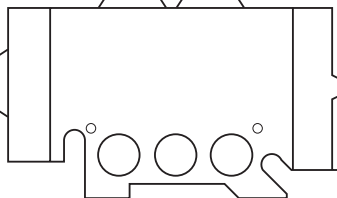

or

Ø4 mm Push-in  
connection  
PVA-P12•



PVA-F10\*\* or PVA-F50

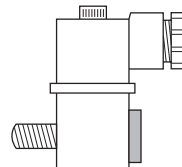

- Power: 6 W 8,5 VA ~ or  
2,5 W 3,5 VA

- Electrical  
connector: 22x30 mm

## 0,9W miniature solenoid with built-in indicator, IP 40

Spring return manual override  
Actuator only

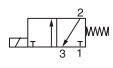

Voltage		Order code	D
12 VDC		<b>PVA-J1302J9</b>	3
24 VDC		<b>PVA-J1302B9</b>	3

Indexable manual override  
Actuator only

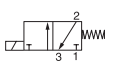

Voltage		Order code	D
12 VDC		<b>PVA-J1352J9</b>	3
24 VDC		<b>PVA-J1352B9</b>	3

Without manual override  
Actuator only

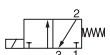

Voltage		Order code	D
12 VDC		<b>PVA-J1392J9</b>	3
24 VDC		<b>PVA-J1392B9</b>	3

Spring return manual override  
With unwired 10 mm cable connector

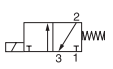

Voltage		Order code	D
12 VDC		<b>PVA-J1302J</b>	3
24 VDC		<b>PVA-J1302B</b>	3

Indexable manual override  
With unwired 10 mm cable connector

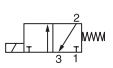

Voltage		Order code	D
12 VDC		<b>PVA-J1352J</b>	3
24 VDC		<b>PVA-J1352B</b>	3

Without manual override  
With unwired 10 mm cable connector

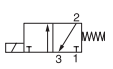

Voltage		Order code	D
12 VDC		<b>PVA-J1392J</b>	3
24 VDC		<b>PVA-J1392B</b>	3

Spring return manual override  
With prewired 10 mm cable connector, cable length L=2 m

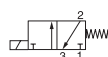

Voltage		Order code	D
12 VDC		<b>PVA-J1302J0</b>	3
24 VDC		<b>PVA-J1302B0</b>	3

Indexable manual override  
With prewired 10 mm cable connector, cable length L=2 m

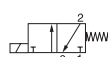

Voltage		Order code	D
12 VDC		<b>PVA-J1352J0</b>	3
24 VDC		<b>PVA-J1352B0</b>	3

Without manual override  
With prewired 10 mm cable connector, cable length L=2 m

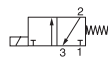

Voltage		Order code	D
12 VDC		<b>PVA-J1392J0</b>	3
24 VDC		<b>PVA-J1392B0</b>	3

Spring return manual override  
With prewired 10 mm cable connector, cable length L=5 m

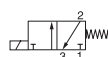

Voltage		Order code	D
12 VDC		<b>PVA-J1302J1</b>	3
24 VDC		<b>PVA-J1302B1</b>	3

Indexable manual override  
With prewired 10 mm cable connector, cable length L=5 m

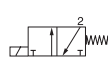

Voltage		Order code	D
12 VDC		<b>PVA-J1352J1</b>	3
24 VDC		<b>PVA-J1352B1</b>	3

Without manual override  
With prewired 10 mm cable connector, cable length L=5 m

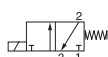

Voltage		Order code	D
12 VDC		<b>PVA-J1392J1</b>	3
24 VDC		<b>PVA-J1392B1</b>	3

Wiring and connecting accessories, please see next page

To order solenoid actuators with built-in overvoltage limiter (for control circuit protection), replace the first digit in the numerical part of the reference by **5**. Example: **PVA-J5352B**

## Wiring and connecting accessories for PVL-A

Connector 2 x 0,128 mm <sup>2</sup>	Order code	D
Connector only (sold in pack of 10 pcs)	<b>PES-D10</b>	3
Connector with 2 m cable	<b>PES-D100</b>	3
Connector with 5 m cable	<b>PES-D101</b>	3
Connector with 10 m cable	<b>PES-D102</b>	3
Terminal to be crimped (sold in pack of 10 pcs)	<b>SY3CM0142</b>	3

## Solenoids 15 mm 1,2 W / 1,6 VA (9,4 mm pin spacing),

Without manual override



Without cable connector

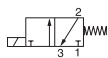

Voltage	Order code	D
12 VDC	<b>PS1-E2492J</b>	3
24 VDC	<b>PS1-E2492B</b>	3
48 VDC	<b>PS1-E2492E</b>	3
24 V 50/60Hz	<b>PS1-E2491B</b>	3
48 V 50/60Hz	<b>PS1-E2491E</b>	3
115 V 50Hz, 120 V 60Hz	<b>PS1-E2491F</b>	3
230 V 50Hz, 240 V 60Hz	<b>PS1-E2491M</b>	3



With prewired 15 mm cable connector, cable length L=2 m

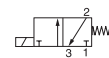

Voltage	Order code	D
24 VDC	<b>PVA-H2492B0</b>	3
48 VDC	<b>PVA-H2492E0</b>	3
24 V 50/60Hz	<b>PVA-H2491B0</b>	3
48 V 50/60Hz	<b>PVA-H2491E0</b>	3
115 V 50Hz, 120 V 60Hz	<b>PVA-H2491F0</b>	3
230 V 50Hz, 240 V 60Hz	<b>PVA-H2491M0</b>	3

With unwired 15 mm cable connector

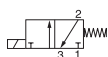

Voltage	Order code	D
24 VDC	<b>PVA-H2492B</b>	1
48 VDC	<b>PVA-H2492E</b>	3
24 V 50/60Hz	<b>PVA-H2491B</b>	1
48 V 50/60Hz	<b>PVA-H2491E</b>	3
115 V 50Hz, 120 V 60Hz	<b>PVA-H2491F</b>	1
230 V 50Hz, 240 V 60Hz	<b>PVA-H2491M</b>	3



With prewired 15 mm cable connector, cable length L=5 m

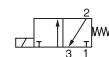

Voltage	Order code	D
24 VDC	<b>PVA-H2492B1</b>	3
48 VDC	<b>PVA-H2492E1</b>	3
24 V 50/60Hz	<b>PVA-H2491B1</b>	3
48 V 50/60Hz	<b>PVA-H2491E1</b>	3
115 V 50Hz, 120 V 60Hz	<b>PVA-H2491F1</b>	3
230 V 50Hz, 240 V 60Hz	<b>PVA-H2491M1</b>	3

## Electrical connector 15x15mm (9,4 mm pin spacing)

Order code	D
Connector to be wired (universal)	<b>PES-C10</b> 3
Connector to be wired with LED+Protection	<b>PES-C2020B</b> 3
24 V DC/AC	

## Electrical connector 15x15mm (9,4 mm pin spacing)

Order code	D
Connector with 2 m cable (earth terminal opposite cable)	<b>PES-C12</b> 3
Connector with 2 m cable with LED+Protection (earth terminal opposite cable) 24 V DC/AC	<b>PES-C2220B</b> 3

**Multi-subbases for solenoid actuators 3/2 PS1-E24...**

Operating pressure 0 to 10 bar

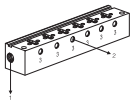

	Connections	Number of positions	Weight Kg	Order code	D
	common air supply	2	0,095	<b>PVU-H13152</b>	3
		4	0,150	<b>PVU-H13154</b>	3
		6	0,200	<b>PVU-H13156</b>	3
	1 G1/8 2 M5	8	0,255	<b>PVU-H13158</b>	3
		10	0,310	<b>PVU-H131510</b>	3

**Air Pilot Connectors**

	Mounting	Type of connection	Weight Kg	Order code	D
	Mounts on the same interface as the 1 W / 1,2 VA solenoid actuator	Push-in Ø4 mm	0,007	<b>PVA-P111</b>	1
		Threaded M5	0,002	<b>PVA-P115</b>	3

**Intermediate Air Pilot Connectors**

For mounting between the PVA-H24I solenoid actuator and the PVL-BI or PVL-CI power valve 5/2 mounted on DIN rail

	Description	Type of connection	Weight Kg	Order code	D
	For pneumatic piloting of the power valve	Straight, Push-in Ø4 mm	0,040	<b>PVA-P171</b>	3
	For external air supply to the 1 W / 1,2 VA miniature solenoid actuators	Swivel, Push-in Ø 4 mm	0,040	<b>PVA-P161</b>	1
		Straight, Push-in Ø 4 mm	0,040	<b>PVA-P163</b>	3

## Solenoids 6 W / 8,5 VA

Without manual override



Without cable connector (22x30 mm)

Voltage		Order code	D
12 VDC		<b>PVA-F192J</b>	3
24 VDC		<b>PVA-F192B</b>	1
48 VDC		<b>PVA-F192E</b>	3
24 V 50/60Hz		<b>PVA-F191B</b>	3
48 V 50/60Hz		<b>PVA-F191E</b>	3
115 V 50Hz, 120 V 60Hz		<b>PVA-F191F</b>	3
230 V 50Hz, 240 V 60Hz		<b>PVA-F191M</b>	3



With unwired cable connector (22x30 mm)

Voltage		Order code	D
24 VDC		<b>PVA-F102B</b>	1
48 VDC		<b>PVA-F102E</b>	3
24 V 50/60Hz		<b>PVA-F101B</b>	1
48 V 50/60Hz		<b>PVA-F101E</b>	3
115 V 50Hz, 120 V 60Hz		<b>PVA-F101F</b>	1
230 V 50Hz, 240 V 60Hz		<b>PVA-F101M</b>	1
255 V 50Hz		<b>PVA-F101U</b>	3

\* Versions available for use in explosive atmospheres:  
 - conforming to certification LCIE 866115 X,  
 - electrical equipment conforming to harmonised European standards



EN 500 14 dated March 1977 (NFC23 514 dated May 1982)  
 EN 500 19 dated March 1977 (NFC23 519 dated May 1982)  
 - marking code EExe II T4 (consult your Technical Sales Office)

With prewired cable connector (22x30 mm), cable length L=2 m

Voltage		Order code	D
24 VDC		<b>PVA-F102B0</b>	3
48 VDC		<b>PVA-F102E0</b>	3
24 V 50/60Hz		<b>PVA-F101B0</b>	3
48 V 50/60Hz		<b>PVA-F101E0</b>	3
115 V 50Hz, 120 V 60Hz		<b>PVA-F101F0</b>	3
230 V 50Hz, 240 V 60Hz		<b>PVA-F101M0</b>	3
255 V 50Hz		<b>PVA-F101U0</b>	3



With prewired cable connector (22x30 mm), cable length L=5 m

Voltage		Order code	D
24 VDC		<b>PVA-F102B1</b>	3
48 VDC		<b>PVA-F102E1</b>	3
24 V 50/60Hz		<b>PVA-F101B1</b>	3
48 V 50/60Hz		<b>PVA-F101E1</b>	3
115 V 50Hz, 120 V 60Hz		<b>PVA-F101F1</b>	3
230 V 50Hz, 240 V 60Hz		<b>PVA-F101M1</b>	3
255 V 50Hz		<b>PVA-F101U1</b>	3

Electrical connector 22x30 mm	Order code	D
Connector to be wired (universal)	<b>PES-A10</b>	3
Connector to be wired with LED+Protection 24 V DC/AC	<b>PES-A2020B</b>	1
Connector to be wired with LED+Protection 230 VAC	<b>PES-A2001M</b>	3
Connector with 2 m cable (earth terminal opposite cable)	<b>PES-A12</b>	3
Connector with 2 m cable with LED+Protection (earth terminal opposite cable) 24 V DC/AC	<b>PES-A2220B</b>	3

## Air Pilot Connectors



Mounting	Type of connection	Weight Kg	Order code	D
 Mounts on the same interface as the 5 W / 6 VA solenoid actuator	Push-in Ø4 mm, elbow	0,004	<b>PVA-P121</b>	3
	Push-in Ø4 mm, swivel	0,007	<b>PVA-P122</b>	3
	Threaded M5	0,004	<b>PVA-P125</b>	3

## Head and tail sets

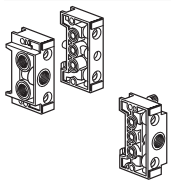
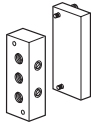
For stacking power valves 5/2, sizes M5, G1/8 and G1/4

	Type of mounting	Description	Valve size	Port size	Weight Kg	Order code	D
	DIN rail mounting	Single air supply head and tail set	M5	G1/8	0,065	<b>PVL-A1718</b>	1
			1/8"	G1/4	0,175	<b>PVL-B1719</b>	1
			1/4"	G3/8	0,195	<b>PVL-C1713</b>	1
	Dual air supply head and tail set	M5	G1/4	0,080	<b>PVL-A1728</b>	1	
		1/8"	G1/4	0,245	<b>PVL-B1729</b>	1	
		1/4"	G3/8	0,285	<b>PVL-C1723</b>	1	
	Surface mounting	Dual air supply head and tail set	1/8"	G1/8	0,200	<b>PVL-B1818</b>	3
			1/4"	G1/4	0,225	<b>PVL-C1819</b>	3
	Dual air supply head and tail set	1/8"	G1/8	0,260	<b>PVL-B1828</b>	3	
		1/4"	G1/4	0,280	<b>PVL-C1829</b>	3	

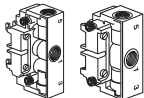
## Components for stacking two sizes of power valve

	Type of mounting	Description	Valve size	Weight Kg	Order code	D
Components for stacking 2 sizes: "transfer/take-off" module and corresponding head and tail set						
	On DIN rail	<b>Kit for stacking power valves :</b> - one "transfer/take-off" module  - two head and tail sets with one in each size.	M5 and 1/8"	0,120	<b>PVU-LBA118</b>	3
			1/8" and 1/4"	0,642	<b>PVU-LCB119</b>	3
Components for intermediate supply						
	On DIN rail	Intermediate supply module	1/8"		<b>PVU-LBB118</b>	3
			1/4"		<b>PVU-LCC119</b>	3
Components for inlet/exhaust common gallery sealing						
		<b>Kit for sealing the commons:</b> - 3 common blanking plugs - 2 drilled and threaded rods - 2 screws for extended tie rods	M5	0,020	<b>PVL-A1901</b>	1
			1/8"	0,035	<b>PVL-B1901</b>	1
			1/4"	0,065	<b>PVL-C1901</b>	3

## Spare Mounting and assembly kits

	Contents	Valve size	Base component	Weight Kg	Order code	D
- Seals for common inlet/exhaust ports	1 pack of 30 O-ring seals	1/8"	PVL-B17•• PVL-B18•• PVL-B12••••	0,009	<b>PPR-V23</b>	3
		1/4"	PVL-C17•• PVL-C18•• PVL-C12••••	0,017	<b>PPR-V24</b>	3
- Seals for pneumatic piloting or solenoid actuator connectors	1 pack of 50 O-ring seals for pneumatic piloting connectors type PVA-P12•		PVA-P122 PVA-P121 PVA-P125	0,007	<b>PPR-V25</b>	3
	1 pack of 20 seals for solenoid actuator type PVA-H24 and pneumatic piloting connector type PVA-P11•		PVL-B11•6•• PVL-B12•6•• PVL-C11•6•• PVL-C12•6••	0,004	<b>PPR-V20</b>	1
- Fixing accessories	1 pack of 20 hooks for head and tail modules		PVL-B17•• PVL-C17••	0,110	<b>PPR-L09</b>	1
	1 pack of 10 stacking rods for 1/8" power valves		PVL-B12••••	0,040	<b>PPR-V21</b>	1
	1 pack of 10 stacking rods for 1/4" power valves		PVL-C12••••	0,058	<b>PPR-V22</b>	1



## Dimensions, PVL valve Series

All dimensions in mm unless otherwise stated

### M5 stand-alone power valves with pneumatic or electrical piloting

Electrical piloting with 0,9 W solenoid actuator

Monostable PVL-A1113\*\*

Bistable PVL-A1123\*\*

Pneumatic piloting

Monostable PVL-A1111\*\*

Bistable PVL-A1121\*\*

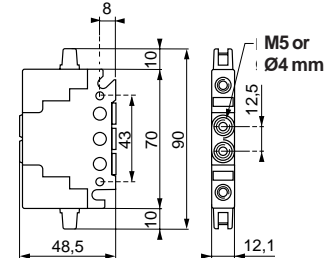
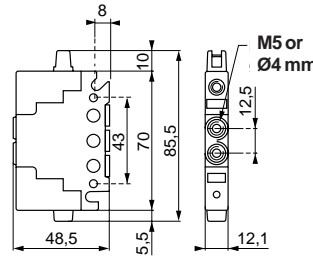
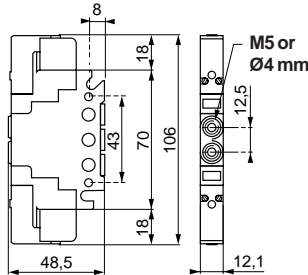
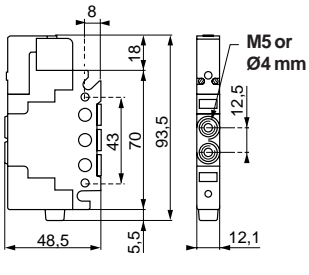

### M5 stand-alone power valves with pneumatic or electrical piloting

Electrical piloting with 0,9 W solenoid actuator

Monostable PVL-A1213\*\*

Bistable PVL-A1223\*\*

Pneumatic piloting

Monostable PVL-A1211\*\*

Bistable PVL-A1221\*\*

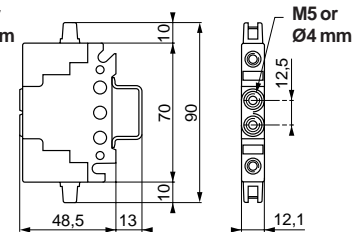
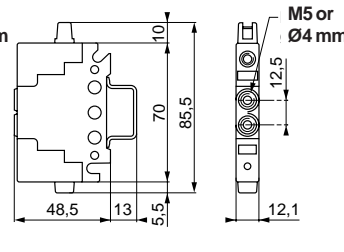
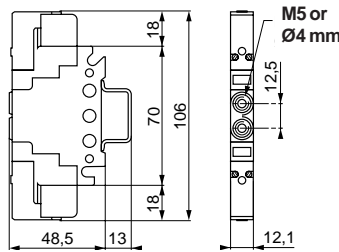
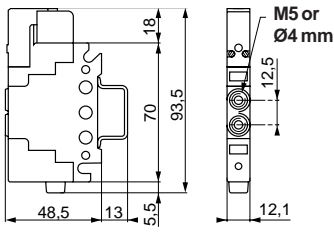

### Head and tail sets

- Mounting on DIN rail

Single air supply PVL-A1718

Dual air supply PVL-A1728

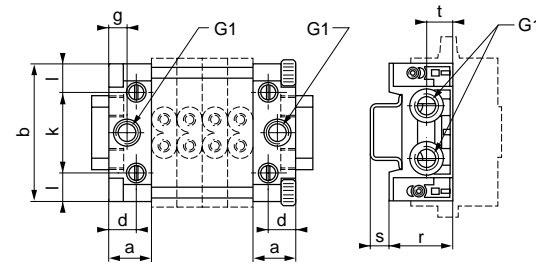
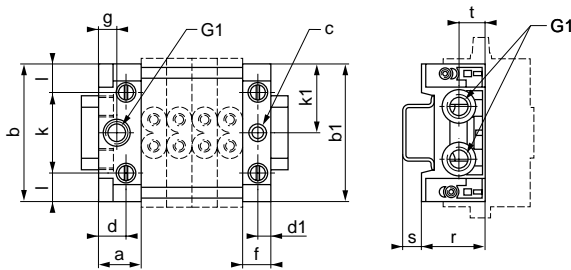

Thread size	a	b	b1	c	d	d1	f	g	G1	k	k1	l	r	s	t
M5	20	65	65	4,2	12,9	5,9	13	8,5	1/8"	38	38	13,5	30	8,8	12,5

### "Transfer / take-off module"

For combination of M5 - 1/8" sizes - PVU-LBA118

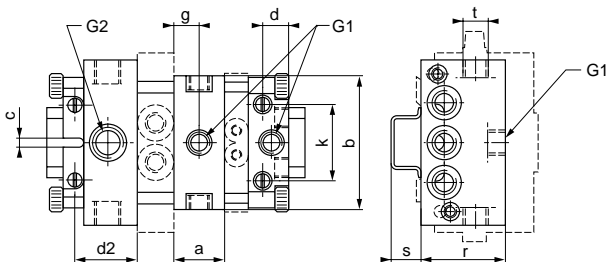

Thread size	a	b	c	d	d2	g	G1	G2	k	r	s	t
G1/8 - M5	25	67	4,2	12,9	31,3	12,5	1/8"	1/4"	38	34	14,8	11,9

## Stand-alone power valves 1/8" without piloting accessories

Monostable PVL-B1116\*\*, PVL-B1136\*\*

Bistable PVL-B1126\*\*

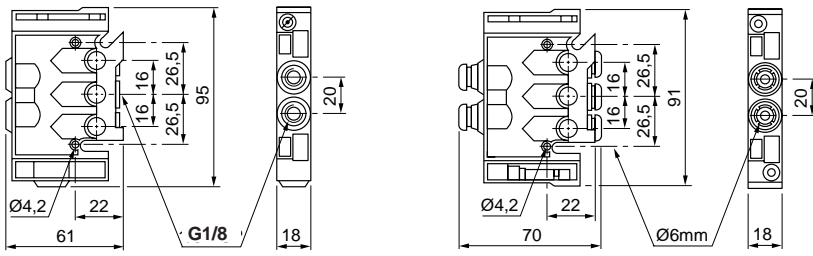

## Stacking power valves 1/8" with pneumatic or electrical piloting

Monostable PVL-B1216\*\*, PVL-B1236\*\*

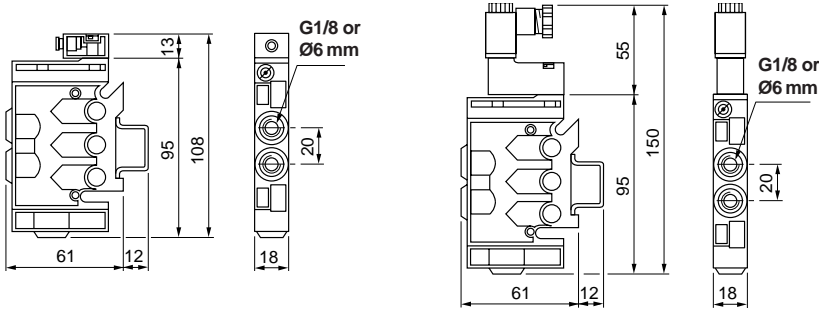

Bistable PVL-B1226\*\*

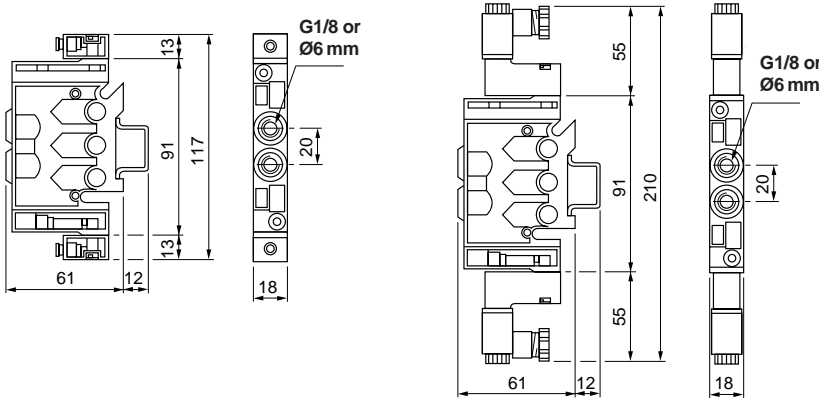

**Stand-alone power valves 1/4" without piloting accessories**  
**Monostable PVL-C1116\*\*, PVL-C1136\*\*, PVL-C1114\*\*, PVL-C1134\*\***

**Bistable PVL-C1126\*\*, PVL-C1124\*\***

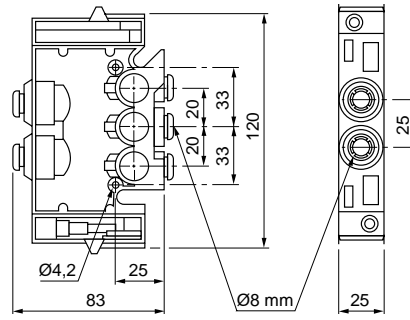
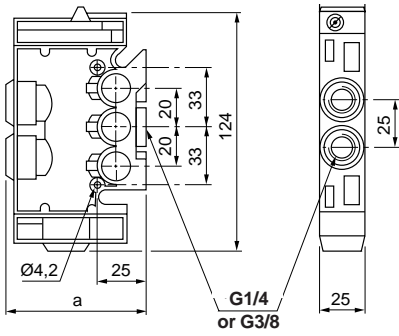

	G1/4	G3/8
a	73	88

**Stacking power valves 1/4" with pneumatic or electrical control**  
**With 1 W solenoid actuator and suitable pneumatic connector**  
**Monostable PVL-C1216\*\*, PVL-C1236\*\***

**Bistable PVL-C1226\*\***

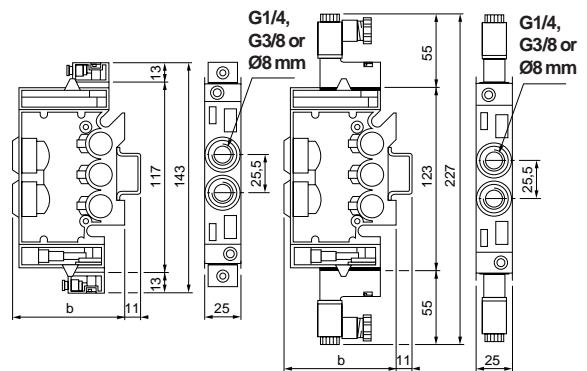
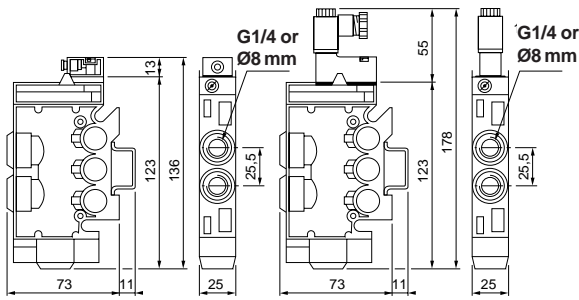

	G1/4	G3/8
b	73	77

**With 5W solenoid actuator and suitable pneumatic connector**  
**Monostable PVL-C1214\*\*, PVL-C1234\*\***

**Bistable PVL-C1224\*\***

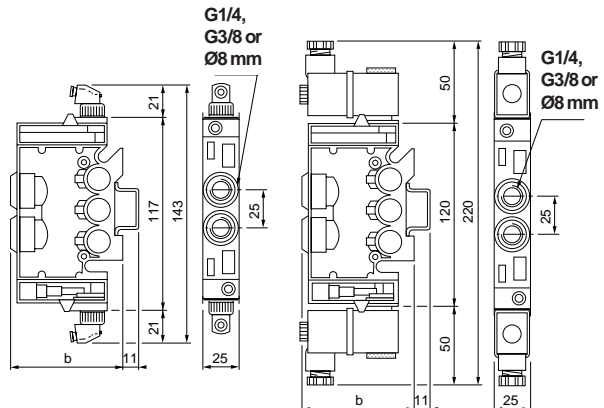
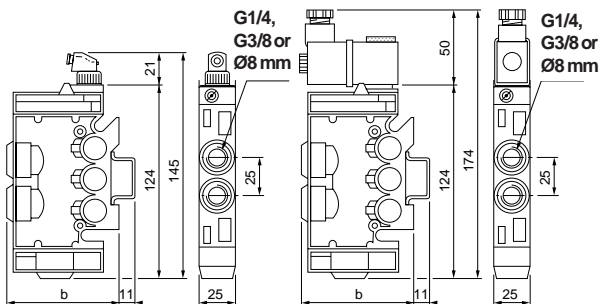

## Head and tail sets

Single air supply  
PVL-B1719, PVL-C1713, mounting on DIN rail

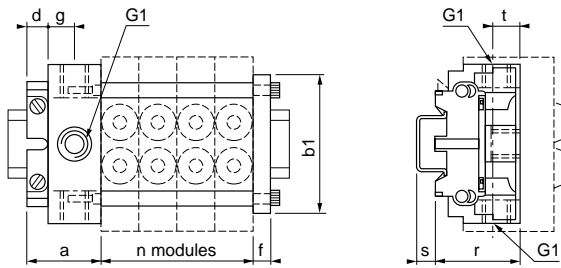

Dual air supply  
PVL-B1729, PVL-C1723, mounting on DIN rail

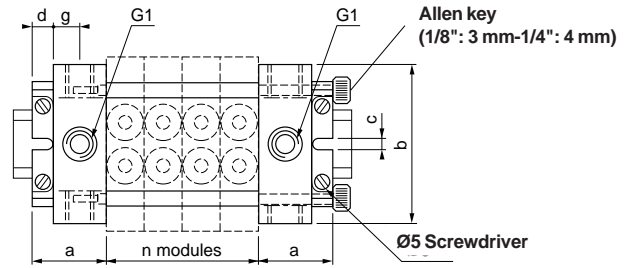

Single air supply  
PVL-B1818, PVL-C1819, "stack mounting"

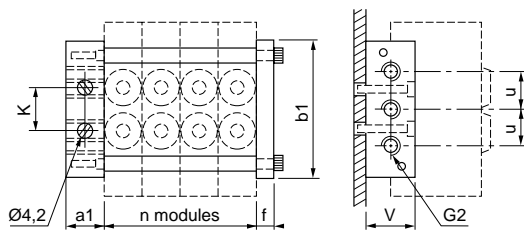

	a	a1	b	b1	c	d	f	g	G1	G2	k	r	s	t	u	v
1/8"	38	16	83	70	4,2	10	8	12	1/4"	1/8"	17,3	44	9	11	16	25
1/4"	38	20	108	100	4,2	10	8	12	3/8"	1/4"	63,5	55	9	13	20	30

"Transfer / take-off" module, intermediate supply module  
For combination of sizes 1/4" - 1/8" - PVU-LCB119

PVUL-BB118 - PVU-LCC119

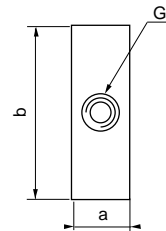
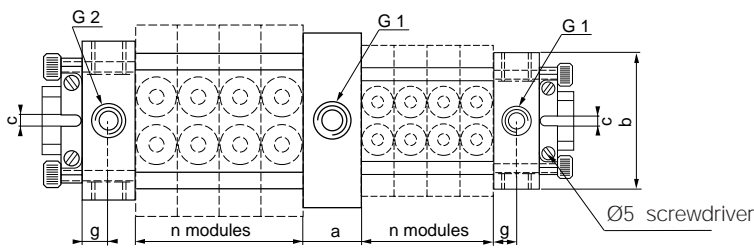

	a	b	G
1/8"	18	75	1/8"
1/4"	25	100	1/4"

Intermediate piloting connectors  
PVA-P171

PVA-P161

PVA-P163

