



Viking Xtreme

High performance directional control valves
G1/8 - G1/2 body ported

Catalogue PDE2569TCUK. Edition February 10

aerospace
climate control
electromechanical
filtration
fluid & gas handling
hydraulics
pneumatics
process control
sealing & shielding



ENGINEERING YOUR SUCCESS.

Material Specification.....	6
Flow Characteristics.....	8
Order Key - Viking Xtreme Pneumatic + Lever Valves.....	9
Main Data Pneumatic + Lever Operated Valves.....	10 - 11
Order Key - Normal Operating Pressure.....	12
Main Data Electrically Actuated Directional Control Valves Normal	13 - 16
Order Key - Viking Xtreme Valves.....	17
Main Data Electrically Actuated Directional Control Valves Xtreme.....	18 - 19
Dimensions - P2LAX / P2LBX / P2LCX / P2LDX.....	20 - 27
P2LA, Flexible Manifold Assembly	28
P2LA, Accessorie Order Codes	29 - 32
Manifold Dimensions.....	27 - 32
Solenoid Valves - 15mm.....	33
Solenoid Valves Order Key - 15mm.....	34
Solenoid Valves Technical Data - 15mm.....	35
Solenoid Valves - 22mm.....	36
Solenoid Valves Order Key - 22mm.....	37
Solenoid Valves Technical Data - 22mm.....	38
Solenoid Connectors + Cable Plugs.....	39
Service and Replacement Parts.....	40



Important !
 Before carrying out any service work, ensure that the valve and manifold have been vented. Remove the primary supply air hose to ensure total disconnection of the air supply before dismantling valves or blank connection blocks.



NB !
 All technical data in this catalogue is typical only. The air quality is decisive for the valve life: see ISO 8573.



WARNING

FAILURE OR IMPROPER SELECTION OR IMPROPER USE OF THE PRODUCTS AND/OR SYSTEMS DESCRIBED HEREIN OR RELATED ITEMS CAN CAUSE DEATH, PERSONAL INJURY AND PROPERTY DAMAGE.
 This document and other information from Parker Hannifin Corporation, its subsidiaries and authorized distributors provide product and/or system options for further investigation by users having technical expertise. It is important that you analyze all aspects of your application and review the information concerning the product or system in the current product catalog. Due to the variety of operating conditions and applications for these products or systems, the user, through its own analysis and testing, is solely responsible for making the final selection of the products and systems and assuring that all performance, safety and warning requirements of the application are met. The products described herein, including without limitation, product features, specifications, designs, availability and pricing, are subject to change by Parker Hannifin Corporation and its subsidiaries at any time without notice.

SALE CONDITIONS

The items described in this document are available for sale by Parker Hannifin Corporation, its subsidiaries or its authorized distributors. Any sale contract entered into by Parker will be governed by the provisions stated in Parker's standard terms and conditions of sale (copy available upon request).

Extreme Environments Demand The Viking Xtreme



The Viking Xtreme valve range is robust, versatile and combines high performance with compact installation dimensions. Large flow capacity, short change-over times and low change-over pressure are important characteristics of this valve range.

The 1/8 & 1/4 sizes are designed to operate with pressures up to 16 bar and the 3/8 & 1/2 sizes up to 12 bar, in ambient temperatures -40°C to + 60°C when fitted with suitable solenoid operators.

Viking Xtreme range

- P2LAX, dimension G1/8**
- P2LBX, dimension G1/4**
- P2LCX, dimension G3/8**
- P2LDX, dimension G1/2**

New manually operated valves

The range now includes lever operated versions. They feature a rugged hand lever specifically designed for gloved hands and are available in 5/2 and 5/3 functions



Over-moulded single piece aluminium spool

- Reduced product complexity
- Increased flow
- Wide operating temperature range.
- Stable seal performance even with high flow/pressure drop across spool.

Whatever the environment, Push it to the Xtreme



Compact installation dimensions - flexible installation

Compact dimensions direct body porting and integral mounting holes are all features of the Viking Xtreme range. In addition to single valve installation, the Viking valve may be installed on manifolds so that the valves have a common supply and manifolded exhausts.

Mobile applications

The Viking Xtreme valves have a robust body which is machined out of solid aluminium bar and then anodised. Valves have passed aggressive salt spray, and demanding vibration tests and will operate in ambient temperatures of -40°C to $+60^{\circ}\text{C}$. Solenoids are available having wide voltage tolerance for mobile applications.

Maintenance

The Viking Xtreme valve range has been developed from the very successful VGD15 and P2L-A product ranges which have a history of reliable and long service life in demanding and difficult applications. Spares kits are available for the valve and solenoid operators.

Now available in manually operated versions

The range has now been extended to include lever operated versions. The rugged lever actuator has been specifically designed for gloved hands to suit mobile applications in the most arduous of environments. Available in 5/2 and 5/3 functions with either spring return or detented lever and with a choice of mid position function in the 5/3 versions. The lever actuated versions are available across the entire range of port sizes G1/8, G1/4, G3/8 and G1/2.

High reliability

Valves easily comply with the requirements for the component reliability in accordance with EU Machinery Directive standards EN292-2 and EN983.

The Viking Xtreme valves have few moving parts combined with short spool movement, these features combine to give valves having high reliability and long service life. The valves are designed for use with or without supplementary lubrication.

Rust and corrosion resistant designs.

Viking valves are made entirely of anodized aluminium, for good corrosion resistance. The smooth design, with no dirt-collecting pockets, makes the valve suitable for most environments, including applications with stringent hygiene requirements. The valve has stainless steel fixing screws for the end covers, to withstand aggressive environments.

Insensitive to dirty air

Thanks to large flow passage areas and the large flow diameter of 1.0 in the pilot valves, the P2LA and P2LB can be used in normal industrial or mobile environments without any problems of blocking. However the service life of the valve depends on the cleanliness of the air. Please refer to ISO 8573. Valves having ATEX approval ATEX approved options are available for use in explosive atmospheres. Consult our Technical Sales Department for further information.



Road

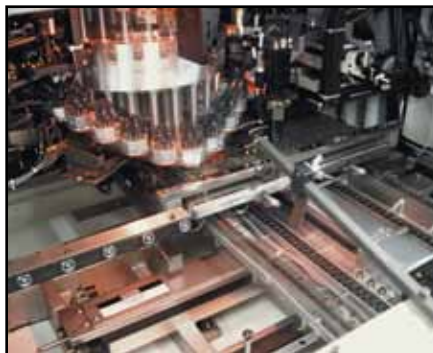

Industrial



Oil & Gas



Flexible multiple installation

There is a system of multiple installation plates, intermediate blocks and several variants of connectors for the P2LA. Several variants of connectors are available, which permit connection from above, beneath, straight from the side or in the middle of a valve block. Using the type L manifold, valve blocks may be constructed for supplying several different pressures.

Manifold bar installation

A manifold bar, with common ducts for ports 1, 3 and 5 gives simple, time saving and easily serviced installation. Manifold bars are available in several different sizes, with space for between 2 and 14 valves. They are designed for simple handling and are entirely serviced from the front.

Pressure bar installation

A pressure bar for common primary air supply gives a simple, robust, time saving and easily serviced installation. When pressure bars are used, restrictor-silencers can be installed in the exhaust ports of each valve, for individual adjustment of cylinder/air motor speed. Pressure bars are available in a number of different sizes, with space ranging from 2 to 10 valves.



Rail



Agri-Food



Forestry

Working medium, air quality

Working medium: Dry, filtered compressed air to ISO 8573-1 class 3.4.3.

Recommended air quality for valves

For best possible service life and trouble free operation, ISO 8573-1 quality class 3.4.3 should be used. This means 5µm filter (standard filter) dew point +3°C for indoor operation (a lower dew point should be selected for outdoor operation) and oil concentration 1.0 mg oil/m³, which is what a standard compressor with a standard filter gives.

ISO 8573-1 quality classes

Quality class	Pollution		Water max. press. dew point (°C)	Oil max. concentration (mg/m ³)
	particle size (µm)	max. concentration (mg/m ³)		
1	0,1	0,1	-70	0,01
2	1	1	-40	0,1
3	5	5	-20	1,0
4	15	8	+3	5,0
5	40	10	+7	25
6	-	-	+10	-

Typical cylinders speeds which can be achieved with Viking valves and different tube sizes.

In the chart below you can find the suitable valves, tubes etc. for each cylinder size. If you have a tube length over 2 m, choose one tube size larger than in the chart.

Following data is valid:

- Supply pressure : min 7,0 bar
- Regulator pressure setting : 6,0 bar
- Pipe length between air treatment unit and valve : max 1 m
- Pipe length between valve and cylinder : max 2 m

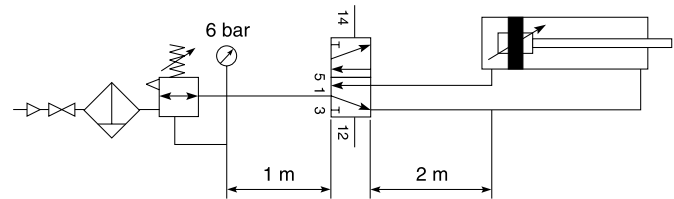

Cylinder bore	<20	20-32	40-50	63	80	100	125	160	200
Cylinder port	M5	G1/8	G1/4	G3/8	G3/8	G1/2	G1/2	G3/4	G3/4
Tubing Ext/Int	4/2.7	6/4	8/6	10/8	10/8	12/9	14/11	18/15	20/18
			6/4	8/6	12/9	14/11			
P2LAX	G1/8	G1/8	G1/8	G1/8	G1/8				
P2LBX	G1/4	G1/4	G1/4	G1/4	G1/4	G1/4			
P2LCX			G3/8	G3/8	G3/8	G3/8	G3/8		
P2LDX				G1/2	G1/2	G1/2	G1/2	G1/2	G1/2

Cylinder speed < 0,5 m/s
 Cylinder speed < 1 m/s

Oversized
 Cylinder speed > 1 m/s

Material specification

P2LAX

Valve

Valve body	Anodised aluminium
End covers	Anodised aluminium
Lever housing	Acetal plastic
Spool	Aluminium + nitrile rubber
Piston	Acetal plastic/ Anodised aluminium
End cover sealings	Nitrile rubber
End cover screws	Stainless steel
Springs	Dacromet® - processed steel, Stainless steel
Lever	Reinforced polyamid plastic
Panel mounting nut	Polycarbonate plastic
Gaiter	Chloroprene rubber
Mounting screws for solenoid	Stainless steel

Accessories

Manifold bar	Anodised aluminium
Pressure bar	Anodised aluminium
Multiple manifolds	Anodised aluminium
End and intermediate blocks	Anodised aluminium

P2LCX

Valve

Valve body	Anodised aluminium
End covers	Anodised aluminium
Spool	Aluminium + nitrile rubber
Piston	Acetal plastic/ Anodised aluminium
End cover sealings	Nitrile rubber
End cover screws	Stainless steel
Springs	Dacromet® - processed steel, Stainless steel
Mounting screws for solenoid	Stainless steel

P2LBX

Valve

Valve body	Anodised aluminium
End covers	Anodised aluminium
Lever housing	Anodised aluminium
Spool	Aluminium + nitrile rubber
Piston	Acetal plastic/ Anodised aluminium
End cover sealings	Nitrile rubber
End cover screws	Stainless steel
Springs	Dacromet® - processed steel, Stainless steel
Mounting screws for solenoid	Stainless steel

Accessories

Manifold bar	Anodised aluminium
Pressure bar	Anodised aluminium

P2LDX

Valve

Valve body	Anodised aluminium
End covers	Anodised aluminium
Spool	Aluminium + nitrile rubber
Piston	Acetal plastic/ Anodised aluminium
End cover sealings	Nitrile rubber
End cover screws	Stainless steel
Springs	Dacromet® - processed steel, Stainless steel
Mounting screws for solenoid	Stainless steel

Flow characteristics

Flow capacities in accordance with ISO6358
 All pressures = effective pressure
 The curves in the diagram below are typical only

Technical Data P2LAX

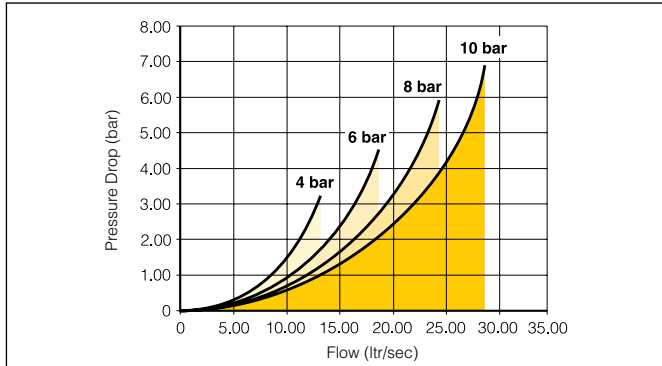

Port size	G1/8
Max operating pressure.	16 bar
Working temperature.	
Air pilot lever solenoid.	-40°C to + 60°C
Standard and food version.	-10°C to + 50°C
Mobile version.	-40°C to + 50°C
Flow (acc. to ISO 6358)	$c = 3,0 \text{ NI/s} \times \text{bar}$ $b = 0,2$ $Q_n = 11,0 \text{ l/s}$ $Q_{max} = 19,0 \text{ l/s}$ $C_v = 0,65$

Technical Data P2LBX

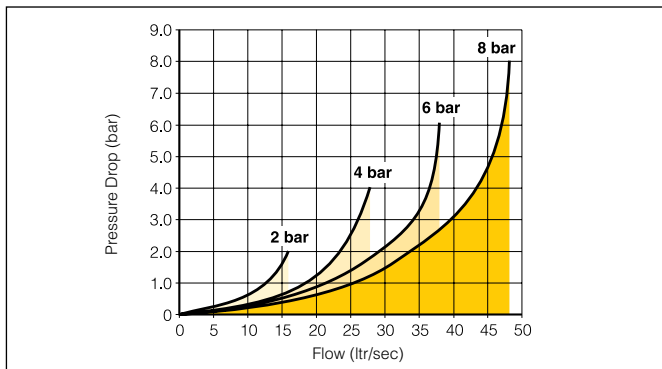

Port size	G1/4
Max operating pressure.	16 bar
Working temperature.	
Air pilot solenoid.	-40°C to + 60°C
Standard and food version.	-10°C to + 50°C
Mobile version.	-40°C to + 50°C
Flow (acc. to ISO 6358)	$c = 5,4 \text{ NI/s} \times \text{bar}$ $b = 0,2$ $Q_n = 21,5 \text{ l/s}$ $Q_{max} = 38,0 \text{ l/s}$ $C_v = 1,33$

Technical Data P2LCX

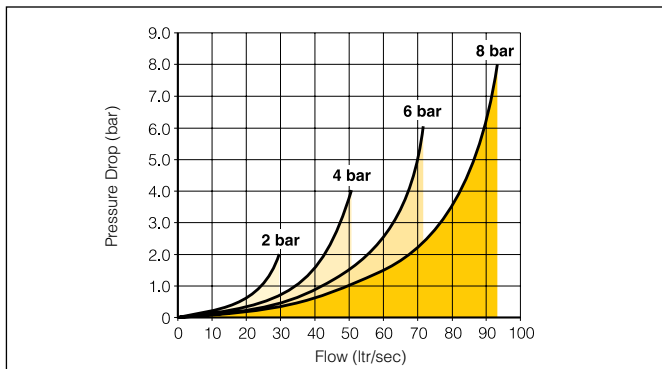

Port size	G3/8
Max operating pressure.	12 bar
Working temperature.	
Air pilot lever solenoid.	-40°C to + 60°C
Air pilot solenoid.	-40°C to + 60°C
Standard and food version.	-10°C to + 50°C
Mobile version.	-40°C to + 50°C
Flow (acc. to ISO 6358)	$c = 10,3 \text{ NI/s} \times \text{bar}$ $b = 0,22$ $Q_n = 41,0 \text{ l/s}$ $Q_{max} = 72,0 \text{ l/s}$ $C_v = 2,5$

Technical Data P2LDX

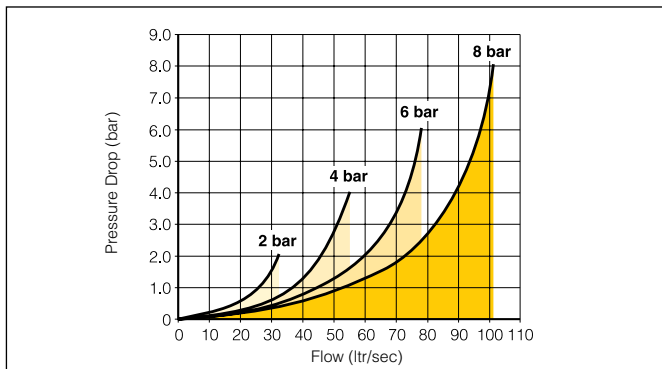



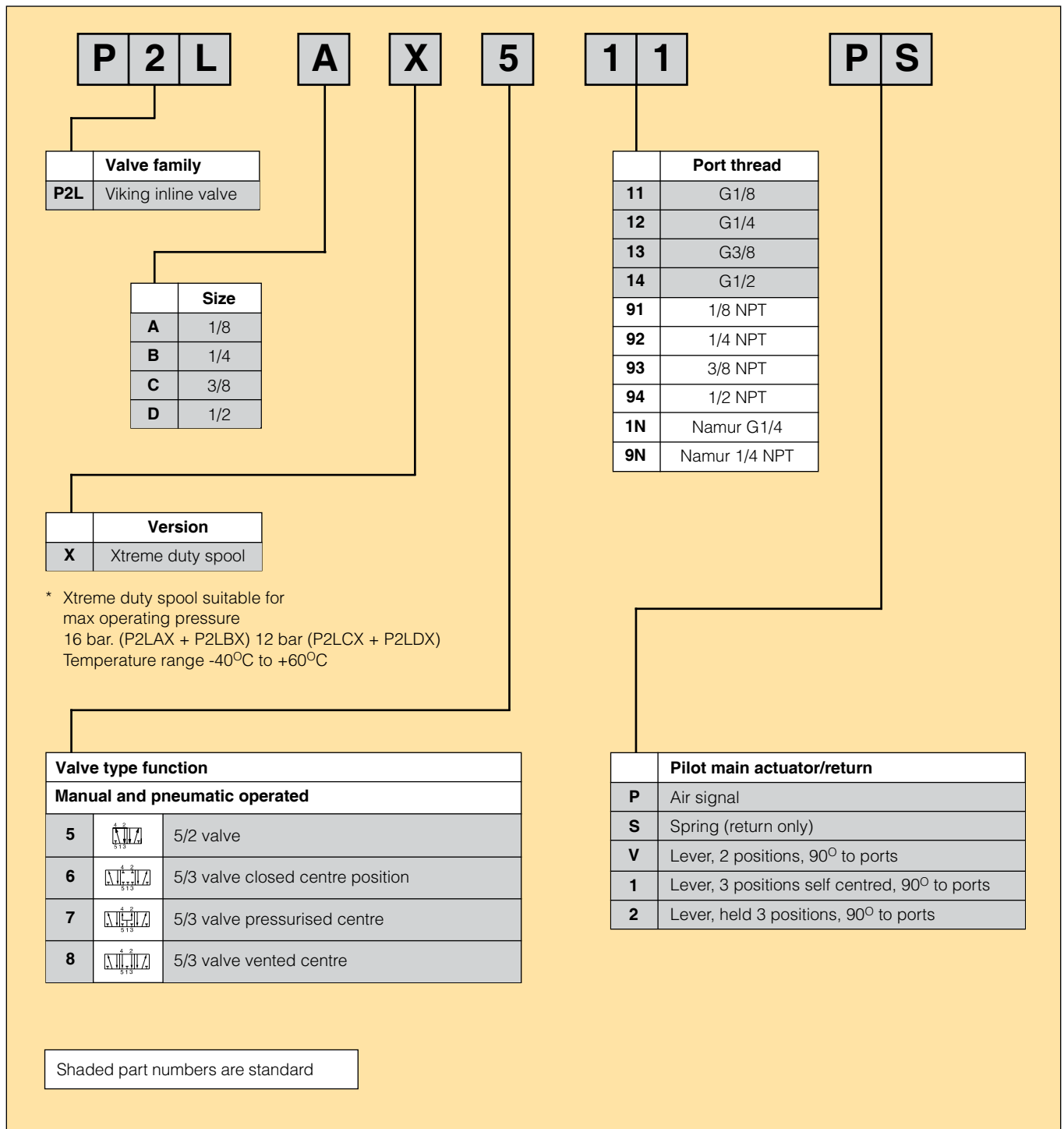

Port size	G1/2
Max operating pressure.	12 bar
Working temperature.	
Air pilot lever solenoid.	-40°C to + 60°C
Air pilot solenoid.	-40°C to + 60°C
Standard and food version.	-10°C to + 50°C
Mobile version.	-40°C to + 50°C
Flow (acc. to ISO 6358)	$c = 11,3 \text{ NI/s} \times \text{bar}$ $b = 0,3$ $Q_n = 44,3 \text{ l/s}$ $Q_{max} = 78 \text{ l/s}$ $C_v = 2,71$

Order chart - Viking Xtreme air pilot & lever valves - Xtreme operating pressure / temperature







Pneumatic and lever operated valves - Xtreme operating pressure / temperature

Max operating pressure 16 bar (A & B) 12 bar (C & D). temp range -40°C to +60°C

Symbol	Size	Actuation	Return	Min Operating Pressure (bar)	Changeover time (ms) at 6 bar @20°C actua./return	Weight Kg	Order code
5/2 valves, temperature -40°C to +60°C							
	G1/8	Air signal	Air signal	1,5	5/5	0,14	P2LAX511PP
	G1/4			1,5	6/6	0,30	P2LBX512PP
	G3/8			1,5	8/8	0,45	P2LCX513PP
	G1/2			1,5	9/9	0,45	P2LDX514PP
	G1/8	Air signal	Spring	3,2	8/15	0,15	P2LAX511PS
	G1/4			3,5	10/20	0,32	P2LBX512PS
	G3/8			3,5	10/30	0,45	P2LCX513PS
	G1/2			3,5	10/30	0,45	P2LDX514PS
5/3 valves, temperature -40°C to +60°C							
	G1/8	Air signal	Air signal	3,5	10/20	0,15	P2LAX611PP
	G1/4	Closed centre	Self	3,5	12/22	0,33	P2LBX612PP
	G3/8	position	centring	3,5	15/35	0,50	P2LCX613PP
	G1/2			3,5	15/35	0,50	P2LDX614PP
	G1/8	Air signal	Air signal	3,5	10/20	0,15	P2LAX811PP
	G1/4	Vented centre	Self	3,5	12/22	0,33	P2LBX812PP
	G3/8	position	centring	3,5	15/35	0,50	P2LCX813PP
	G1/2			3,5	15/35	0,50	P2LDX814PP
	G1/8	Air signal	Air signal	3,5	10/20	0,15	P2LAX711PP
	G1/4	Pressurised	Self	3,5	12/22	0,33	P2LBX712PP
	G3/8	centre	centring	3,5	15/35	0,50	P2LCX713PP
	G1/2	position		3,5	15/35	0,50	P2LDX714PP

Lever operated directional control valves

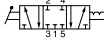
Max operating pressure 16 bar (A & B) 12 bar (C & D). temp range -40°C to +60°C

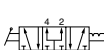
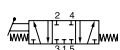
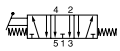
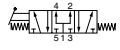
Symbol	Size	Actuation	Return	Changeover angle	Type	Weight Kg	Order code
5/2 valves, standard temperature / Low temperature, lever 90° to ports							
	G1/8	Lever	Lever	28°	Std.	0,18	P2LAX511VV
	G1/4	Lever	Lever	20°	Std.	0,33	P2LBX512VV
	G3/8	Lever	Lever	32°	Std.	0,40	P2LCX513VV
	G1/2	Lever	Lever	32°	Std.	0,60	P2LDX514VV
	G1/8	Lever	Spring	28°	Std.	0,18	P2LAX511VS
	G1/4	Lever	Spring	20°	Std.	0,33	P2LBX512VS
	G3/8	Lever	Spring	32°	Std.	0,40	P2LCX513VS
	G1/2	Lever	Spring	32°	Std.	0,60	P2LDX514VS
5/3 valves, low temperature, lever 90° to ports							
	G1/8	Lever	Lever	±14°	Std.	0,18	P2LAX61122
	G1/4	Closed centre position held in three positions		±12°	Std.	0,33	P2LBX61222
	G3/8		±16°	Std.	0,71	P2LCX61322	
	G1/2		±16°	Std.	0,73	P2LDX61422	
	G1/8		Lever	Lever	±14°	Std.	0,18
	G1/4	Exhausted centre position held in three positions		±12°	Std.	0,33	P2LBX81222
	G3/8		±16°	Std.	0,71	P2LCX81322	
	G1/2		±16°	Std.	0,73	P2LDX81422	
	G1/8		Lever	Lever	±14°	Std.	0,18
	G1/4	Pressure applied centre position held in three positions		±12°	Std.	0,33	P2LBX71222
	G3/8		±16°	Std.	0,71	P2LCX71322	
	G1/2		±16°	Std.	0,73	P2LDX71422	
	G1/8		Lever	Lever	±14°	Std.	0,18
	G1/4	Closed centre position Self centring		±12°	Std.	0,33	P2LBX61211
	G3/8		±16°	Std.	0,71	P2LCX61311	
	G1/2		±16°	Std.	0,73	P2LDX61411	
	G1/8		Lever	Lever	±14°	Std.	0,18
	G1/4	Exhausted centre position Self centring		±12°	Std.	0,33	P2LBX81211
	G3/8		±16°	Std.	0,71	P2LCX81311	
	G1/2		±16°	Std.	0,73	P2LDX81411	
	G1/8		Lever	Lever	±14°	Std.	0,18
	G1/4	Pressure applied centre position Self centring		±12°	Std.	0,33	P2LBX71211
	G3/8		±16°	Std.	0,71	P2LCX71311	
	G1/2		±16°	Std.	0,73	P2LDX71411	

Order chart - Viking Xtreme Normal Operating Pressure / Temperature

P	2	L	A	X	5	1	1	E	S	N	D	D	B	4	9
----------	----------	----------	----------	----------	----------	----------	----------	----------	----------	----------	----------	----------	----------	----------	----------

Valve family	
P2L	Viking inline valve









Size	
A	1/8
B	1/4
C	3/8
D	1/2

Version	
X	Xtreme duty spool

Port thread	
11	G1/8
12	G1/4
13	G3/8
14	G1/2
91	1/8 NPT
92	1/4 NPT
93	3/8 NPT
94	1/2 NPT
1N	Namur G1/4
9N	Namur 1/4 NPT

Solenoid pilot type	
N	10 bar / -10°C to 50°C
L**	10 bar / -10°C to 50°C

Solenoid exhaust	
D	Vented
N	Captured/tapped M5
X	15mm solenoid vented

Valve type function		
Solenoid operated with internal supply to solenoid		
5		5/2 valve
6		5/3 valve closed centre position
7		5/3 valve pressurised centre
8		5/3 valve vented centre
Solenoid operated with external pilot supply to solenoids through ports #12 & #14		
N		5/2 valve
P		5/3 valve closed centre position
Q		5/3 valve pressurised centre
R		5/3 valve vented centre

Overrides	
A*	None
B*	Flush - non locking
C	Flush - locking
D¹	Extended non-locking
E*	Extended - locking
X	Less 15mm solenoid

* Only available with enclosure 5
¹ 22mm solenoid option

Voltage ²			
	AC		DC
	60Hz	50Hz	
40	12		
42	24	22	
45			12
47*			12
48*			24
49			24
53	120	110	
57	240	230	
XX	valve less solenoid/coil		

² If 22mm solenoid required on mobile applications use model code no page 16. Alternatively check operating temperature and pressures with our technical department.

Pilot main actuator / Return	
E	Solenoid operated valve
S	Spring (return only)
P	Press (return only)

Shaded part numbers are standard

Solenoid enclosure / Lead length	
5	15mm, 3 pin Form C/ISO15217 in line with body
B	22mm 3-pin Industrial Form B with coil
N	22mm solenoid pilot less coil
X	Valve less 15mm solenoid
L**	Low power 22mm solenoid (only available with 24V DC)

Solenoid operated directional control valves fitted with 15mm solenoid(s) 24V DC

Solenoid plug/connector to ordered separately. See page 39

Internal supply to solenoid valve(s) via port 1. Max operating pressure 10 bar, temp range -10°C to +50°C

Symbol	Size	Actuation	Return	Min Operating Pressure (bar)	Changeover time (ms) at 6 bar @20°C actua./return	Weight Kg	Order code
5/2 valves, internal air, standard temperature							
	G1/8	Electric signal	Electric signal	1,5	10/10	0,27	P2LAX511EENXB549
	G1/4			1,5	12/12	0,42	P2LBX512EENXB549
	G3/8			1,5	17/17	0,53	P2LCX513EENXB549
	G1/2			1,5	17/17	0,53	P2LDX514EENXB549
	G1/8	Electric signal	Spring	3,2	15/35	0,22	P2LAX511ESNXB549
	G1/4			3,5	18/45	0,38	P2LBX512ESNXB549
	G3/8			3,5	25/75	0,50	P2LCX513ESNXB549
	G1/2			3,5	25/75	0,50	P2LDX514ESNXB549
5/3 valves, internal air, standard temperature							
	G1/8	Electric signal	Electric signal	3,5	18/40	0,28	P2LAX611EENXB549
	G1/4	Closed centre	Self	3,5	22/55	0,44	P2LBX612EENXB549
	G3/8	position	centring	3,5	30/90	0,55	P2LCX613EENXB549
	G1/2			3,5	30/95	0,55	P2LDX614EENXB549
	G1/8	Electric signal	Electric signal	3,5	18/40	0,28	P2LAX811EENXB549
	G1/4	Vented centre	Self	3,5	22/55	0,44	P2LBX812EENXB549
	G3/8	position	centring	3,5	30/90	0,55	P2LCX813EENXB549
	G1/2			3,5	30/95	0,55	P2LDX814EENXB549
	G1/8	Electric signal	Electric signal	3,5	18/40	0,28	P2LAX711EENXB549
	G1/4	Pressurised	Self	3,5	22/55	0,44	P2LBX712EENXB549
	G3/8	centre	centring	3,5	30/90	0,55	P2LCX713EENXB549
	G1/2	position		3,5	30/95	0,55	P2LDX714EENXB549

Solenoid operated directional control valves fitted with adapter to accept 15mm solenoid(s)

Solenoid operator(s) and connector/plug(s) should be ordered separately. See page 35 & 39

Internal supply to solenoid valve(s) via port 1. Max operating pressure 10 bar, temp range -10°C to +50°C

Symbol	Size	Actuation	Return	Min Operating Pressure (bar)	Changeover time (ms) at 6 bar @20°C actua./return	Weight Kg	Order code
5/2 valves, internal air, standard temperature							
	G1/8	Electric signal	Electric signal	1,5	10/10	0,27	P2LAX511EENXXX
	G1/4			1,5	12/12	0,42	P2LBX512EENXXX
	G3/8			1,5	17/17	0,45	P2LCX513EENXXX
	G1/2			1,5	17/17	0,45	P2LDX514EENXXX
	G1/8	Electric signal	Spring	3,2	15/35	0,22	P2LAX511ESNXXX
	G1/4			3,5	18/45	0,38	P2LBX512ESNXXX
	G3/8			3,5	25/75	0,42	P2LCX513ESNXXX
	G1/2			3,5	25/75	0,42	P2LDX514ESNXXX
	G1/8	Electric signal	Air signal	1,5	10/10	0,22	P2LAX511EPNXXX
	G1/4			1,5	12/12	0,38	P2LBX512EPNXXX
	G3/8			1,5	17/17	0,76	P2LCX513EPNXXX
	G1/2			1,5	17/17	0,80	P2LDX514EPNXXX
5/3 valves, internal air, standard temperature							
	G1/8	Electric signal	Electric signal	3,5	18/40	0,28	P2LAX611EENXXX
	G1/4	Closed centre	Self	3,5	22/55	0,44	P2LBX612EENXXX
	G3/8	position	centring	3,5	30/90	0,55	P2LCX613EENXXX
	G1/2			3,5	30/95	0,55	P2LDX614EENXXX
	G1/8	Electric signal	Electric signal	3,5	18/40	0,28	P2LAX811EENXXX
	G1/4	Vented centre	Self	3,5	22/55	0,44	P2LBX812EENXXX
	G3/8	position	centring	3,5	30/90	0,55	P2LCX813EENXXX
	G1/2			3,5	30/95	0,55	P2LDX814EENXXX
	G1/8	Electric signal	Electric signal	3,5	18/40	0,28	P2LAX711EENXXX
	G1/4	Pressurised	Self	3,5	22/55	0,44	P2LBX712EENXXX
	G3/8	centre	centring	3,5	30/90	0,55	P2LCX713EENXXX
	G1/2	position		3,5	30/95	0,55	P2LDX714EENXXX

Solenoid operated directional control valves fitted with adapter to accept 15mm solenoid(s)

Solenoid operator(s) and connector/plug(s) should be ordered separately. See page 35 & 39

External supply to solenoid valve(s) via ports 12 & 14. Max operating pressure 10 bar, temp range -10°C to +50°C

Symbol	Size	Actuation	Return	Min Operating Pressure (bar)	Changeover time (ms) at 6 bar @20°C actua./return	Weight Kg	Order code
5/2 valves, external air, standard temperature							
	G1/8	Electric signal	Electric signal	1,5	10/10	0,19	P2LAXN11EENXXX
	G1/4			1,5	12/12	0,34	P2LBXN12EENXXX
	G3/8			1,5	17/17	0,45	P2LCXN13EENXXX
	G1/2			1,5	17/17	0,45	P2LDXN14EENXXX
	G1/8	Electric signal	Spring	3,2	15/35	0,18	P2LAXN11ESNXXX
	G1/4			3,5	18/45	0,34	P2LBXN12ESNXXX
	G3/8			3,5	25/75	0,42	P2LCXN13ESNXXX
	G1/2			3,5	25/75	0,42	P2LDXN14ESNXXX
	G1/8	Electric signal	Air signal	1,5	10/10	0,19	P2LAXN11EPNXXX
	G1/4			1,5	12/12	0,34	P2LBXN12EPNXXX
	G3/8			1,5	17/17	0,45	P2LCXN13EPNXXX
	G1/2			1,5	17/17	0,45	P2LDXN14EPNXXX
5/3 valves, external air, standard temperature							
	G1/8	Electric signal	Electric signal	3,5	18/40	0,20	P2LAXP11EENXXX
	G1/4	Closed centre position	Self centring	3,5	22/55	0,36	P2LBXP12EENXXX
	G3/8			3,5	30/90	0,55	P2LCXP13EENXXX
	G1/2			3,5	30/95	0,55	P2LDXP14EENXXX
	G1/8	Electric signal	Electric signal	3,5	18/40	0,20	P2LAXR11EENXXX
	G1/4	Vented centre position	Self centring	3,5	22/55	0,36	P2LBXR12EENXXX
	G3/8			3,5	30/90	0,55	P2LCXR13EENXXX
	G1/2			3,5	30/95	0,55	P2LDXR14EENXXX
	G1/8	Electric signal	Electric signal	3,5	18/40	0,20	P2LAXQ11EENXXX
	G1/4	Pressurised centre position	Self centring	3,5	22/55	0,36	P2LBXQ12EENXXX
	G3/8			3,5	30/90	0,55	P2LCXQ13EENXXX
	G1/2			3,5	30/95	0,55	P2LDXQ14EENXXX

Solenoid operated directional control valves fitted with 22mm solenoid(s) 24V DC

Solenoid plug/connector to be ordered separately. See page 39

Internal supply to solenoid valve(s) via port 1. Max operating pressure 10 bar, Temperature range -10°C to +50°C

Symbol	Size	Actuation	Return	Min Operating Pressure (bar)	Changeover time (ms) at 6 bar @20°C actua./return	Weight Kg	Order code
5/2 valves, internal air, standard temperature							
	G1/8	Electric signal	Electric signal	1,5	10/10	0,27	P2LAX511EENDDB49
	G1/4			1,5	12/12	0,42	P2LBX512EENDDB49
	G3/8			1,5	17/17	0,81	P2LCX513EENDDB49
	G1/2			1,5	17/17	0,81	P2LDX514EENDDB49
	G1/8	Electric signal	Spring	3,2	15/35	0,22	P2LAX511ESNDDB49
	G1/4			3,5	18/45	0,38	P2LBX512ESNDDB49
	G3/8			3,5	27/75	0,76	P2LCX513ESNDDB49
	G1/2			3,5	25/75	0,76	P2LDX514ESNDDB49
5/3 valves, internal air, standard temperature							
	G1/8	Electric signal	Electric signal	3,5	18/40	0,28	P2LAX611EENDDB49
	G1/4	Closed centre	Self centring	3,5	22/55	0,44	P2LBX612EENDDB49
	G3/8	position		3,5	30/90	1,11	P2LCX613EENDDB49
	G1/2			3,5	30/90	1,11	P2LDX614EENDDB49
	G1/8	Electric signal	Electric signal	3,5	18/40	0,28	P2LAX811EENDDB49
	G1/4	Vented centre	Self centring	3,5	22/45	0,44	P2LBX812EENDDB49
	G3/8	position		3,5	30/90	1,11	P2LCX813EENDDB49
	G1/2			3,5	30/90	1,11	P2LDX814EENDDB49
	G1/8	Electric signal	Electric signal	3,5	18/40	0,28	P2LAX711EENDDB49
	G1/4	Pressurised	Self centring	3,5	22/45	0,44	P2LBX712EENDDB49
	G3/8	centre		3,5	30/90	1,11	P2LCX713EENDDB49
	G1/2	position		3,5	30/90	1,11	P2LDX714EENDDB49

Solenoid operated directional control valves

(supplied with 22mm solenoid operator less coil) See page 38 & 39 for coil and connector part numbers





Internal supply to solenoid valve(s) via port 1.

Symbol	Size	Actuation	Return	Min Operating Pressure (bar)	Changeover time (ms) at 6 bar @20°C actua./return	Weight Kg	Order code
5/2 valves, internal air, standard temperature							
	G1/8	Electric signal	Electric signal	1,5	9/9	0,16	P2LAX511EENDDN
	G1/4			1,5	10/10	0,31	P2LBX512EENDDN
	G3/8			1,5	13/13	0,41	P2LCX513EENDDN
	G1/2			1,5	13/13	0,41	P2LDX514EENDDN
	G1/8	Electric signal	Spring	3,2	12/38	0,16	P2LAX511ESNDDN
	G1/4			3,5	14/42	0,31	P2LBX512ESNDDN
	G3/8			3,5	16/60	0,40	P2LCX513ESNDDN
	G1/2			3,5	16/60	0,40	P2LDX514ESNDDN
	G1/8	Electric signal	Air signal	1,5	9/9	0,16	P2LAX511EPNDDN
	G1/4			1,5	10/10	0,31	P2LBX512EPNDDN
	G3/8			1,5	13/13	0,40	P2LCX513EPNDDN
	G1/2			1,5	13/13	0,40	P2LDX514EPNDDN
5/3 valves, internal air, standard temperature							
	G1/8	Electric signal	Electric signal	3,5	15/40	0,17	P2LAX611EENDDN
	G1/4	Closed centre	Self centring	3,5	18/50	0,33	P2LBX612EENDDN
	G3/8	position		3,5	20/65	1,00	P2LCX613EENDDN
	G1/2			3,5	20/70	1,00	P2LDX614EENDDN
	G1/8	Electric signal	Electric signal	3,5	15/40	0,17	P2LAX811EENDDN
	G1/4	Vented centre	Self centring	3,5	18/50	0,33	P2LBX812EENDDN
	G3/8	position		3,5	20/65	1,00	P2LCX813EENDDN
	G1/2			3,5	20/70	1,00	P2LDX814EENDDN
	G1/8	Electric signal	Electric signal	3,5	15/40	0,17	P2LAX711EENDDN
	G1/4	Pressurised	Self centring	3,5	18/50	0,33	P2LBX712EENDDN
	G3/8	centre		3,5	20/65	1,00	P2LCX713EENDDN
	G1/2	position		3,5	20/70	1,00	P2LDX714EENDDN





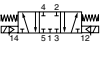
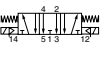



Solenoid operated directional control valves (supplied with 22mm solenoid less coil)

See page 35 & 39 for coil and connector part numbers

External supply to solenoid valve(s) via ports 12 and 14. Standard temp. range -10°C to +50°C. Max operating pressure 10 bar

Symbol	Size	Actuation	Return	Min Operating Pressure (bar)	Changeover time (ms) at 6 bar @20°C actua./return	Weight Kg	Order code
5/2 valves, external air, standard temperature							
	G1/8	Electric signal	Electric signal	1,5	9/9	0,16	P2LAXN11EENDDN
	G1/4			1,5	10/10	0,31	P2LBXN12EENDDN
	G3/8			1,5	13/13	0,70	P2LCXN13EENDDN
	G1/2			1,5	13/13	0,70	P2LDXN14EENDDN
	G1/8	Electric signal	Spring	3,2	12/38	0,16	P2LAXN11ESNDDN
	G1/4			3,5	14/42	0,30	P2LBXN12ESNDDN
	G3/8			3,5	16/60	0,70	P2LCXN13ESNDDN
	G1/2			3,5	16/60	0,70	P2LDXN14ESNDDN
	G1/8	Electric signal	Air signal	1,5	9/9	0,16	P2LAXN11EPNDDN
	G1/4			1,5	10/10	0,32	P2LBXN12EPNDDN
	G3/8			1,5	13/13	0,70	P2LCXN13EPNDDN
	G1/2			1,5	13/13	0,70	P2LDXN14EPNDDN
5/3 valves, external air, standard temperature							
	G1/8	Electric signal	Electric signal	3,5	15/40	0,17	P2LAXP11EENDDN
	G1/4	Closed centre	Self	3,5	18/50	0,33	P2LBXP12EENDDN
	G3/8	position	centring	3,5	20/65	1,00	P2LCXP13EENDDN
	G1/2			3,5	20/70	1,00	P2LDXP14EENDDN
	G1/8	Electric signal	Electric signal	3,5	15/40	0,17	P2LAXR11EENDDN
	G1/4	Vented centre	Self	3,5	18/50	0,33	P2LBXR12EENDDN
	G3/8	position	centring	3,5	20/65	1,00	P2LCXR13EENDDN
	G1/2			3,5	20/70	1,00	P2LDXR14EENDDN
	G1/8	Electric signal	Electric signal	3,5	15/40	0,17	P2LAXQ11EENDDN
	G1/4	Pressurised	Self	3,5	18/50	0,33	P2LBXQ12EENDDN
	G3/8	centre	centring	3,5	20/65	1,00	P2LCXQ13EENDDN
	G1/2	position		3,5	20/70	1,00	P2LDXQ14EENDDN

Order chart - Viking Xtreme Valves - Xtreme operating pressure / temperature





P	2	L	A	X	5	1	1	E	S	H	D	D	B	4	9																																												
Valve family			Port thread			Solenoid pilot type																																																					
P2L Viking inline valve			11 G1/8 12 G1/4 13 G3/8 14 G1/2 91 1/8 NPT 92 1/4 NPT 93 3/8 NPT 94 1/2 NPT			H ¹ 16 bar / -40°C to 60°C																																																					
Size						¹ Solenoid operated 'H' version supplied with B type enclosure 16 bar solenoid																																																					
A 1/8 B 1/4 C 3/8 D 1/2																																																											
Version						Solenoid exhaust																																																					
X Xtreme duty spool						D Vented N Capture/tapped M5																																																					
Valve type function																																																											
Solenoid operated with internal supply to solenoid																																																											
5				5/2 valve																																																							
6				5/3 valve closed centre position																																																							
7				5/3 valve pressurised centre																																																							
8				5/3 valve vented centre																																																							
Solenoid operated with external pilot supply to solenoids through ports #12 & #14																																																											
N				5/2 valve																																																							
P				5/3 valve closed centre position																																																							
Q				5/3 valve pressurised centre																																																							
R				5/3 valve vented centre																																																							
Overrides			Pilot main actuator / Return			Voltage ³																																																					
D Extended non-locking			E Solenoid operated valve S Spring (return only) P Press (return only)			<table border="1" style="width: 100%; border-collapse: collapse;"> <thead> <tr> <th rowspan="2"></th> <th colspan="2">AC</th> <th rowspan="2">DC</th> </tr> <tr> <th>60Hz</th> <th>50Hz</th> </tr> </thead> <tbody> <tr> <td>40</td> <td>12</td> <td></td> <td></td> </tr> <tr> <td>42</td> <td>24</td> <td>22</td> <td></td> </tr> <tr> <td>45</td> <td></td> <td></td> <td>12</td> </tr> <tr> <td>47*</td> <td></td> <td></td> <td>12</td> </tr> <tr> <td>48*</td> <td></td> <td></td> <td>24</td> </tr> <tr> <td>49</td> <td></td> <td></td> <td>24</td> </tr> <tr> <td>53</td> <td>120</td> <td>110</td> <td></td> </tr> <tr> <td>57</td> <td>240</td> <td>230</td> <td></td> </tr> <tr> <td>XX</td> <td colspan="3">valve less solenoid/coil</td> </tr> </tbody> </table>							AC		DC	60Hz	50Hz	40	12			42	24	22		45			12	47*			12	48*			24	49			24	53	120	110		57	240	230		XX	valve less solenoid/coil								
	AC		DC																																																								
	60Hz	50Hz																																																									
40	12																																																										
42	24	22																																																									
45			12																																																								
47*			12																																																								
48*			24																																																								
49			24																																																								
53	120	110																																																									
57	240	230																																																									
XX	valve less solenoid/coil																																																										
						* Mobile voltage see page 32 operating parameters																																																					
						³ Shaded part numbers are available from stock. Unshaded part numbers are available on request but will be subject to minimum order quantities. Otherwise order coil and valve separately.																																																					
						Solenoid enclosure / Lead length																																																					
						A 22mm Solenoid pilot & 30mm coil Form A																																																					
						B 22mm Solenoid pilot & 22mm coil Industrial Form B																																																					
						N 22mm Solenoid pilot less coil																																																					
Shaded part numbers are standard																																																											

Solenoid operated directional control valves - Xtreme duty -40°C to +60°C

P2LAX/P2LBX - 16 bar, P2LCX/P2LDX - 12 bar

Complete with 22mm solenoid and 24V DC coil.

Internal supply to solenoid valve(s) via port 1. Connector/cable plugs to be ordered separately. See page 39

Symbol	Size	Actuation	Return	Min Operating Pressure (bar)	Changeover time (ms) at 6 bar @20°C actua./return	Weight Kg	Order code
5/2 valves, internal air, low temperature							
	G1/8	Electric signal	Electric signal	1,5	11/11	0,27	P2LAX511EEHDB49
	G1/4		Low temp.	1,5	13/13	0,42	P2LBX512EEHDB49
	G3/8			1,5	18/18	0,48	P2LCX513EEHDB49
	G1/2			1,5	18/18	0,48	P2LDX514EEHDB49
	G1/8	Electric signal	Spring	3,2	15/45	0,22	P2LAX511ESHDB49
	G1/4		Low temp.	3,2	20/55	0,38	P2LBX512ESHDB49
	G3/8			3,2	25/85	0,46	P2LCX513ESHDB49
	G1/2			3,2	25/85	0,46	P2LDX514ESHDB49
5/3 valves, internal air, low temperature							
	G1/8	Electric signal	Electric signal	3,5	18/50	0,28	P2LAX611EEHDB49
	G1/4	Closed centre position	Self centring	3,5	25/65	0,45	P2LBX612EEHDB49
	G3/8			3,5	30/90	0,55	P2LCX613EEHDB49
	G1/2		Low temp.	3,5	30/95	0,55	P2LDX614EEHDB49
	G1/8	Electric signal	Electric signal	3,5	18/50	0,28	P2LAX811EEHDB49
	G1/4	Vented centre position	Self centring	3,5	25/65	0,45	P2LBX812EEHDB49
	G3/8			3,5	30/90	0,55	P2LCX813EEHDB49
	G1/2		Low temp.	3,5	30/95	0,55	P2LDX814EEHDB49
	G1/8	Electric signal	Electric signal	3,5	18/50	0,28	P2LAX711EEHDB49
	G1/4	Pressurised centre position	Self centring	3,5	25/65	0,45	P2LBX712EEHDB49
	G3/8			3,5	30/90	0,55	P2LCX713EEHDB49
	G1/2		Low temp.	3,5	30/95	0,55	P2LDX714EEHDB49

Solenoid operated directional control valves - Xtreme duty -40°C to +60°C

P2LAX/P2LBX - 16 bar, P2LCX/P2LDX - 12 bar

Valves fitted with 22mm solenoid operator(s) less coil(s). Order coils and plug/connectors separately

Internal supply to solenoid valve(s) via port 1. See pages 38 & 39 for coils and connectors

Symbol	Size	Actuation	Return	Min Operating Pressure (bar)	Changeover time (ms) at 6 bar @20°C actua./return	Weight Kg	Order code
5/2 valves, internal air, low temperature							
	G1/8	Electric signal	Electric signal	1,5	11/11	0,16	P2LAX511EEHDDN
	G1/4			1,5	13/13	0,31	P2LBX512EEHDDN
	G3/8			1,5	18/18	0,41	P2LCX513EEHDDN
	G1/2			1,5	18/18	0,41	P2LDX514EEHDDN
	G1/8	Electric signal	Spring	3,2	15/45	0,16	P2LAX511ESHDDN
	G1/4			3,2	20/55	0,31	P2LBX512ESHDDN
	G3/8			3,2	25/85	0,40	P2LCX513ESHDDN
	G1/2			3,2	25/85	0,40	P2LDX514ESHDDN
5/3 valves, internal air, low temperature							
	G1/8	Electric signal	Electric signal	3,5	18/50	0,17	P2LAX611EEHDDN
	G1/4	Closed centre	Self	3,5	25/65	0,33	P2LBX612EEHDDN
	G3/8	position	centring	3,5	30/90	0,42	P2LCX613EEHDDN
	G1/2			3,5	30/95	0,42	P2LDX614EEHDDN
	G1/8	Electric signal	Electric signal	3,5	18/50	0,17	P2LAX811EEHDDN
	G1/4	Vented centre	Self	3,5	25/65	0,33	P2LBX812EEHDDN
	G3/8	position	centring	3,5	30/90	0,42	P2LCX813EEHDDN
	G1/2			3,5	30/95	0,42	P2LDX814EEHDDN
	G1/8	Electric signal	Electric signal	3,5	18/50	0,17	P2LAX711EEHDDN
	G1/4	Pressurised	Self	3,5	25/65	0,33	P2LBX712EEHDDN
	G3/8	centre	centring	3,5	30/90	0,42	P2LCX713EEHDDN
	G1/2	position		3,5	30/95	0,42	P2LDX714EEHDDN

Solenoid operated directional control valves - Xtreme duty -40°C to + 60°C

P2LAX/P2LBX - 16 bar, P2LCX/P2LDX - 12 bar

Valves fitted with 22mm solenoid operator(s) less coil(s). Order coils and plug/connectors separately

External supply to solenoid valve(s) via ports 12 & 14. See pages 38 & 39 for coils and connectors

Symbol	Size	Actuation	Return	Min Operating Pressure (bar)	Changeover time (ms) at 6 bar @20°C actua./return	Weight Kg	Order code
5/2 valves, external air to pilot operators							
	G1/8	Electric signal	Electric signal	1,5	11/11	0,27	P2LAXN11EEHDDN
	G1/4			1,5	13/13	0,42	P2LBXN12EEHDDN
	G3/8			1,5	18/18	0,81	P2LCXN13EEHDDN
	G1/2			1,5	18/18	0,81	P2LDXN14EEHDDN
	G1/8	Electric signal	Spring	3,2	15/45	0,22	P2LAXN11ESHDDN
	G1/4			3,2	20/55	0,38	P2LBXN12ESHDDN
	G3/8			3,2	25/85	0,76	P2LCXN13ESHDDN
	G1/2			3,2	25/85	0,76	P2LDXN14ESHDDN
5/3 valves, external air to pilot operators							
	G1/8	Electric signal	Electric signal	3,5	18/50	0,28	P2LAXP11EEHDDN
	G1/4	Closed centre	Self	3,5	25/65	0,44	P2LBXP12EEHDDN
	G3/8	position	centring	3,5	30/90	1,11	P2LCXP13EEHDDN
	G1/2			3,5	30/95	1,11	P2LDXP14EEHDDN
	G1/8	Electric signal	Electric signal	3,5	18/50	0,28	P2LAXR11EEHDDN
	G1/4	Vented centre	Self	3,5	25/65	0,44	P2LBXR12EEHDDN
	G3/8	position	centring	3,5	30/90	1,11	P2LCXR13EEHDDN
	G1/2			3,5	30/95	1,11	P2LDXR14EEHDDN
	G1/8	Electric signal	Electric signal	3,5	18/50	0,28	P2LAXQ11EEHDDN
	G1/4	Pressurised	Self	3,5	25/65	0,44	P2LBXQ12EEHDDN
	G3/8	centre	centring	3,5	30/90	1,11	P2LCXQ13EEHDDN
	G1/2	position		3,5	30/95	1,11	P2LDXQ14EEHDDN

Dimensions

P2LAX... all
5/2 and 5/3 valves

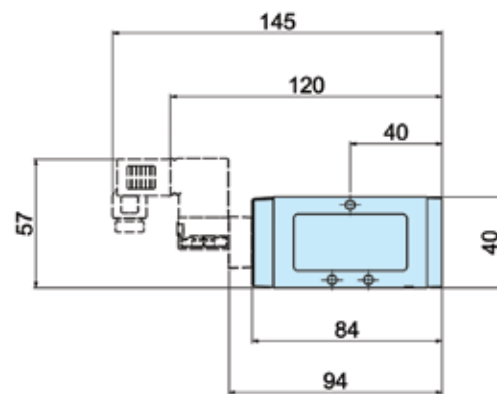
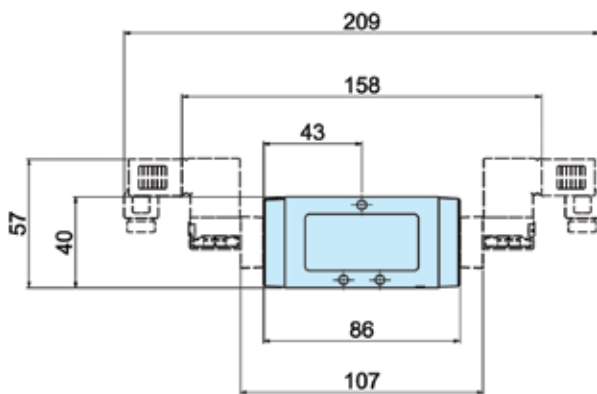
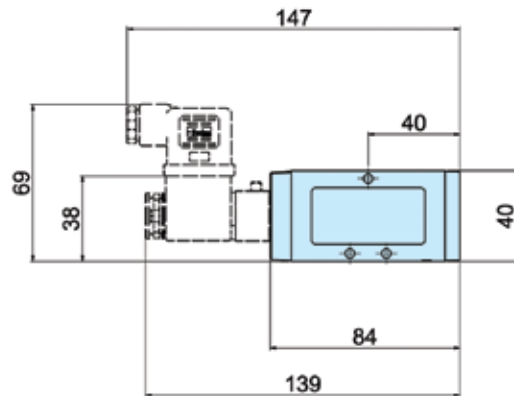
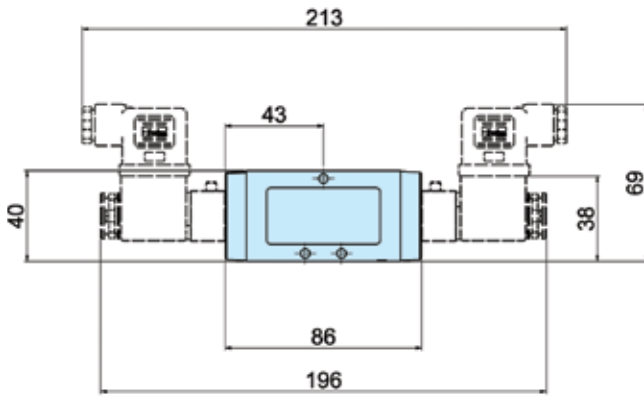
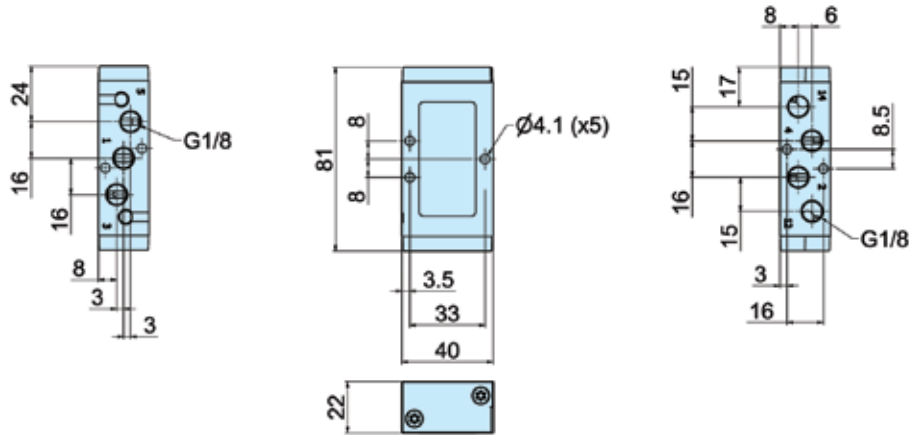

Solenoid valves
Solenoid valves and cable plugs must be ordered separately.
One pilot valve is required for each E in the valve order code.

Dimensions

P2LAX - Lever operated directional control valves

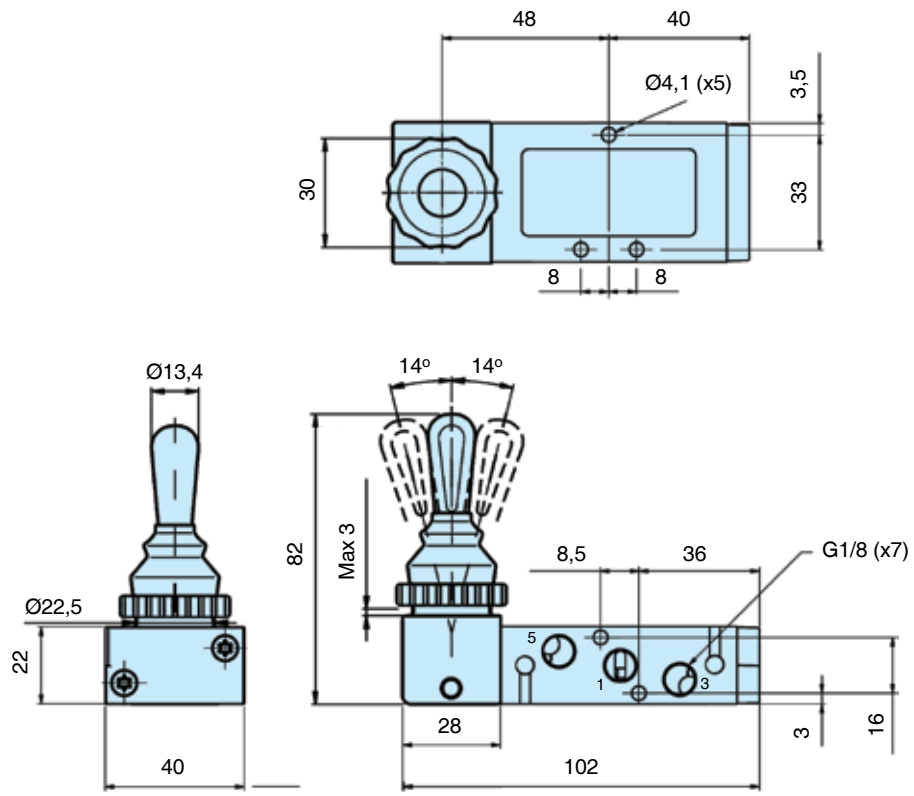

Dimensions

P2LBX - 5/2 Lever operated directional control valves

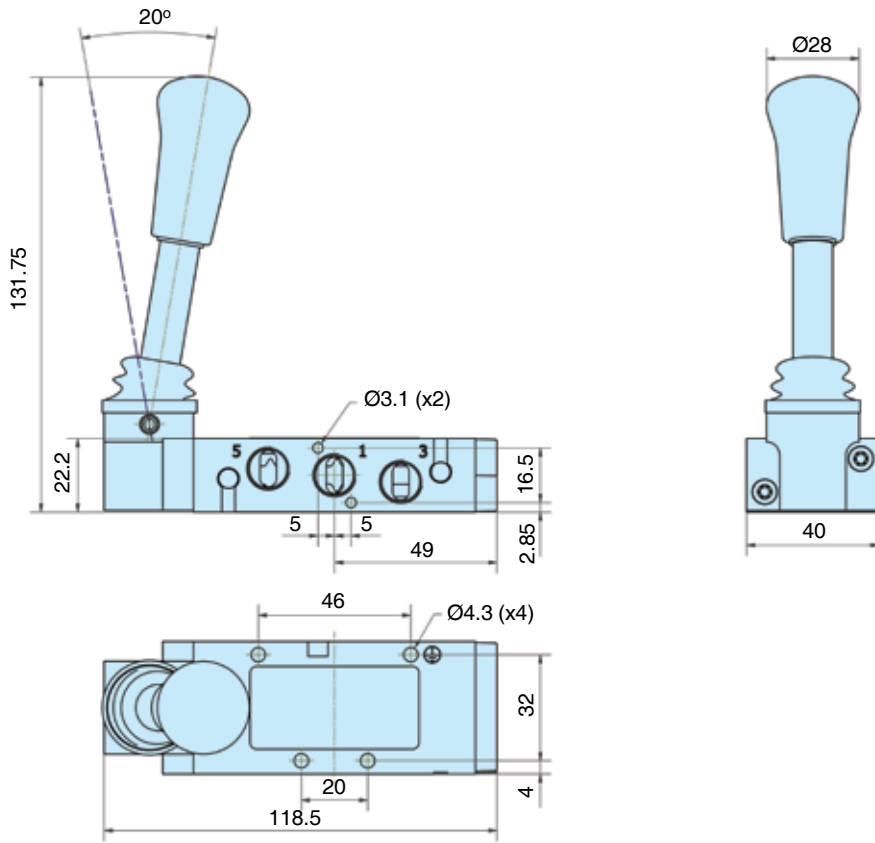

P2LBX - 5/3 Lever operated directional control valves

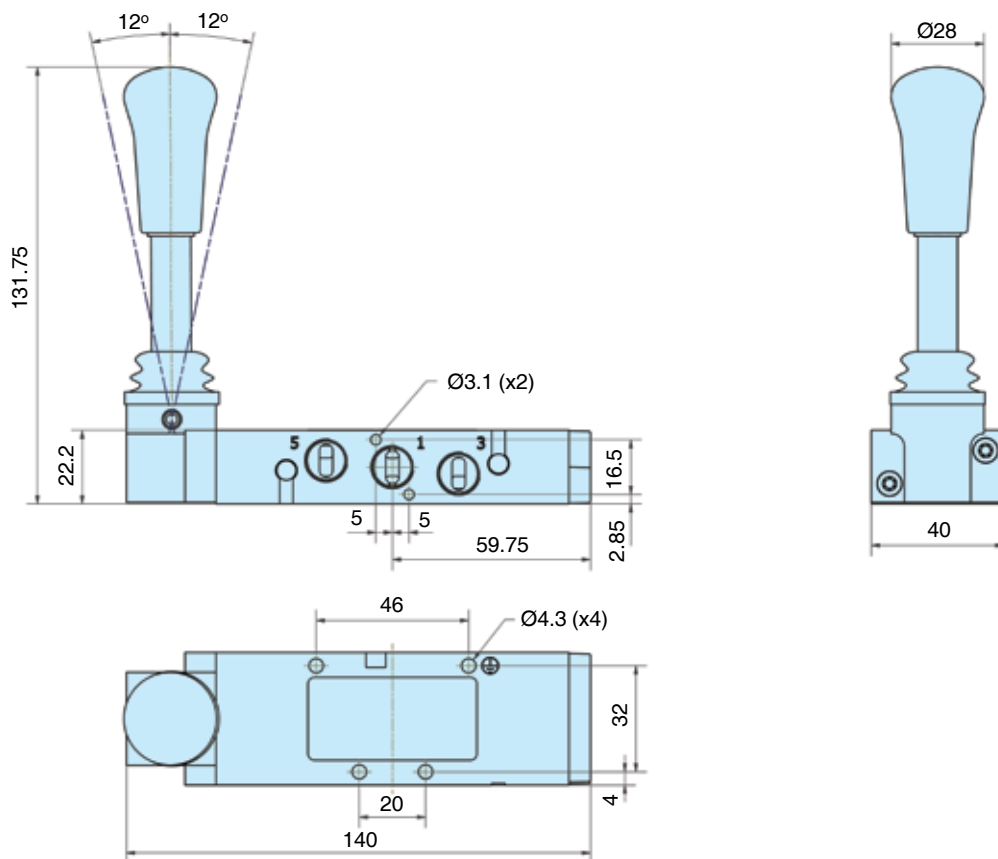

Dimensions

P2LCX - 5/2 Lever operated directional control valves

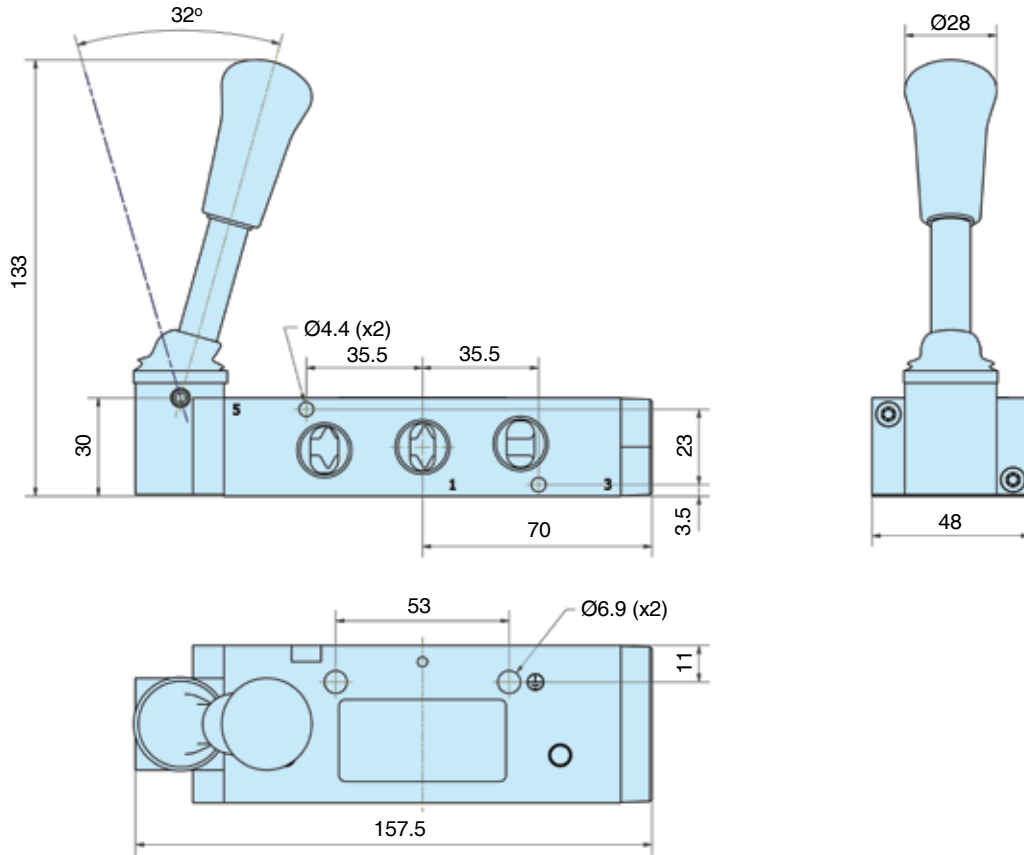

P2LCX - 5/3 Lever operated directional control valves

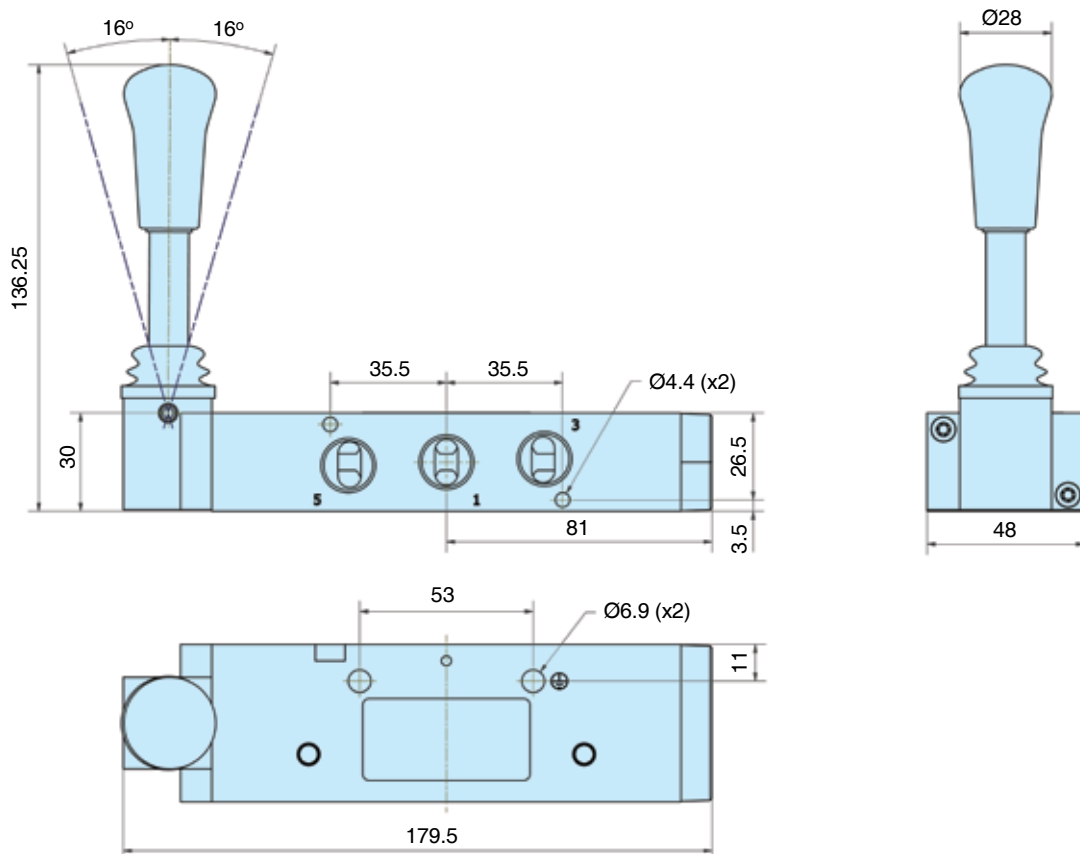

Dimensions

P2LDX - 5/2 Lever operated directional control valves

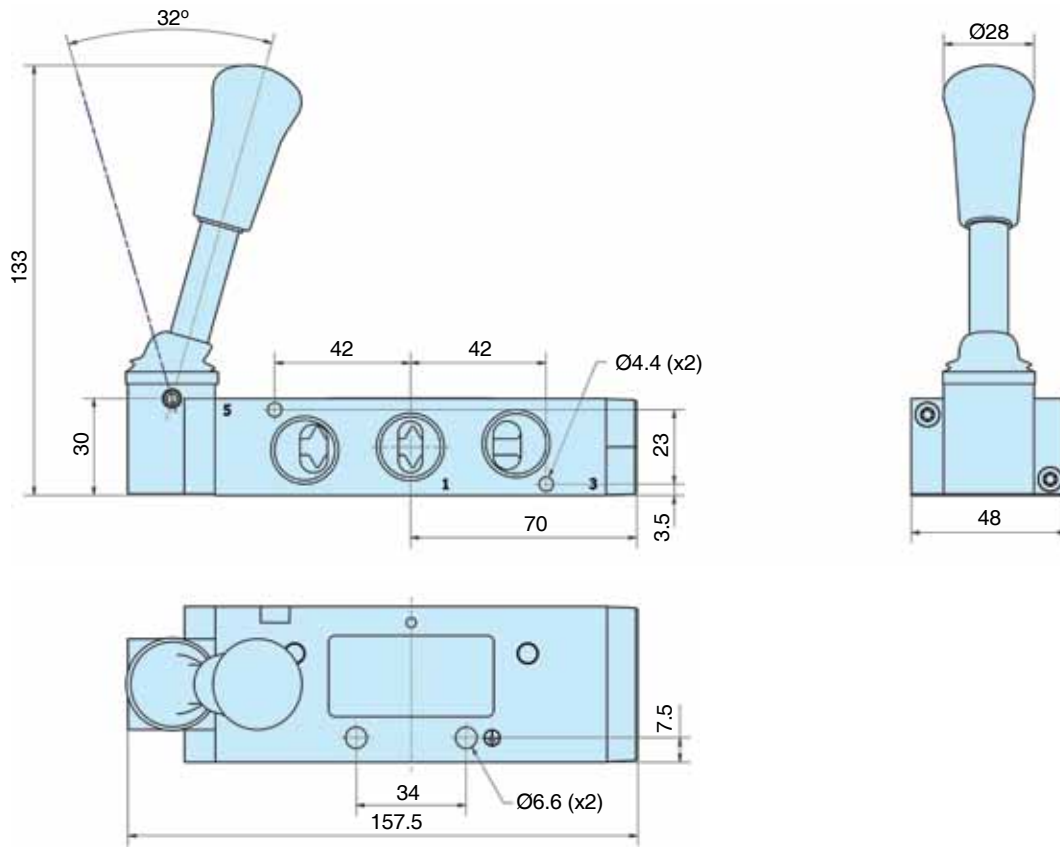

P2LDX - 5/3 Lever operated directional control valves

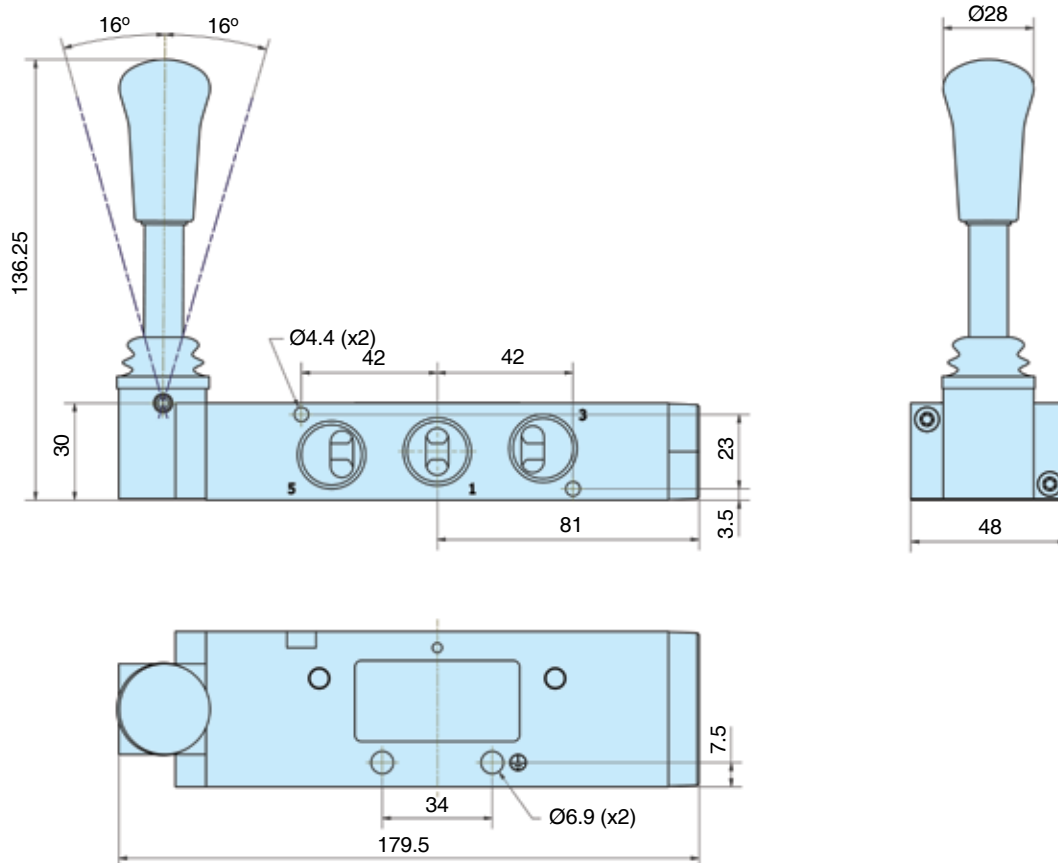

Dimensions

P2LBX... all
5/2 and 5/3 valves

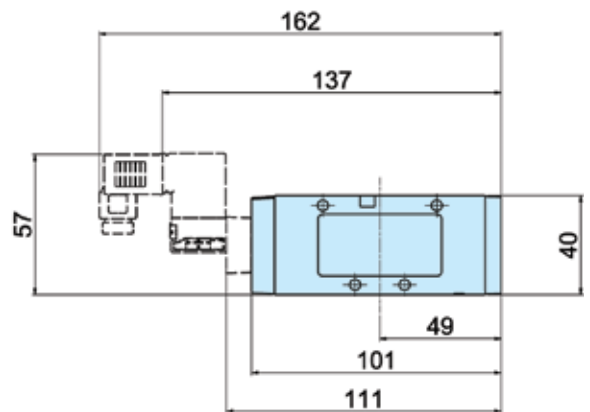
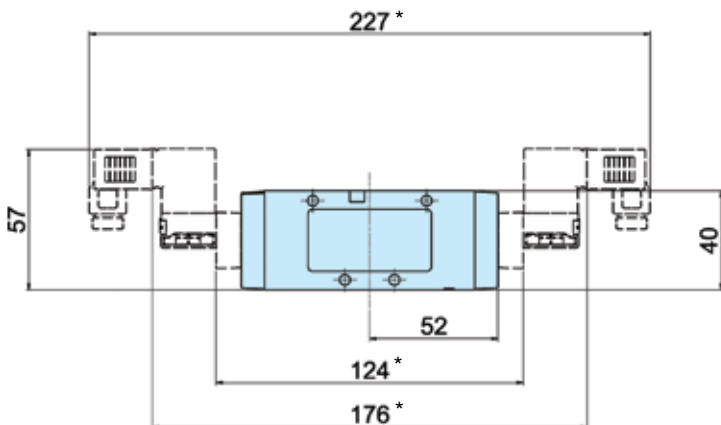
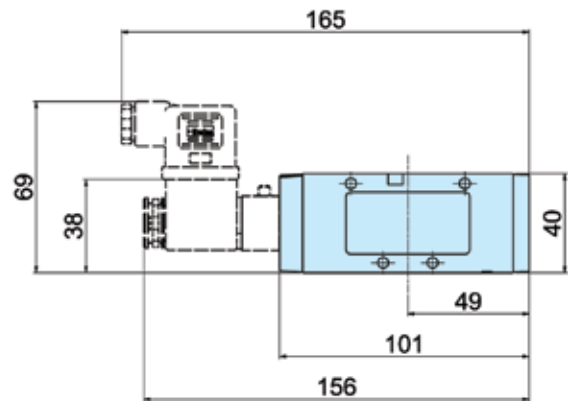
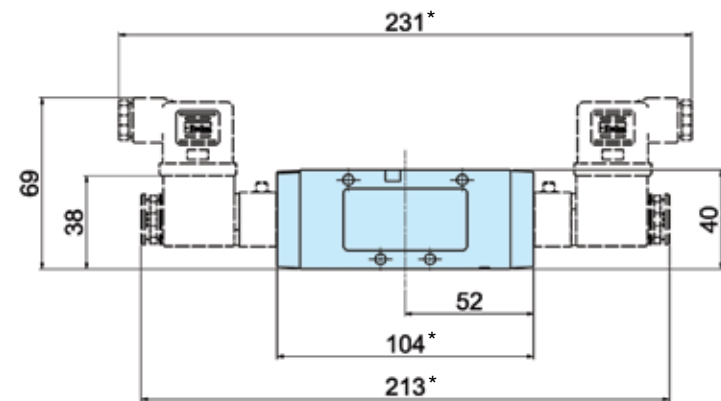
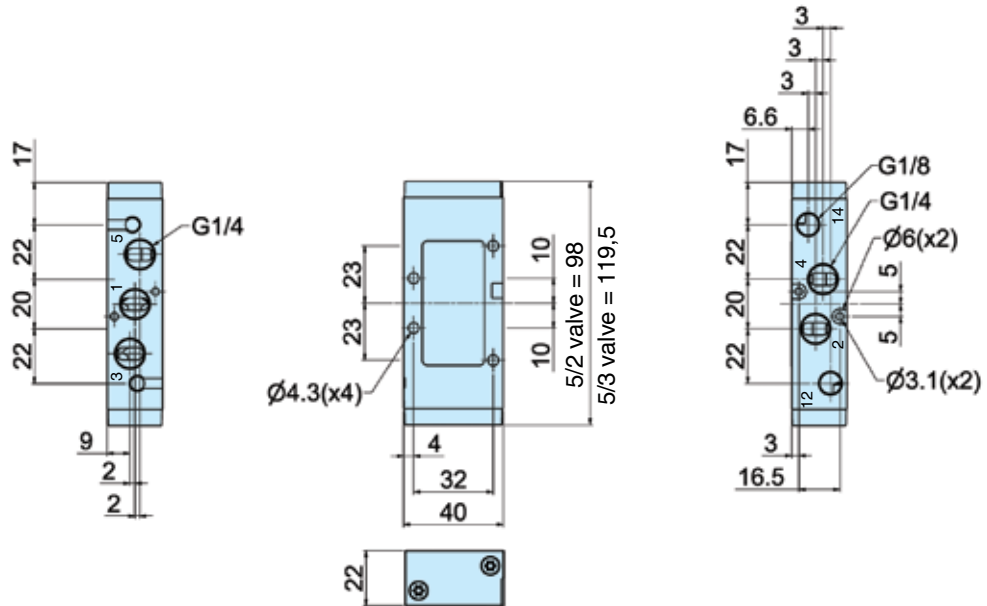

* Note: 5/3 valves - add 21.5mm

Solenoid valves
Solenoid valves and cable plugs must be ordered separately.
One pilot valve is required for each E in the valve order code.

Dimensions

P2LCX... all
5/2 and 5/3 valves

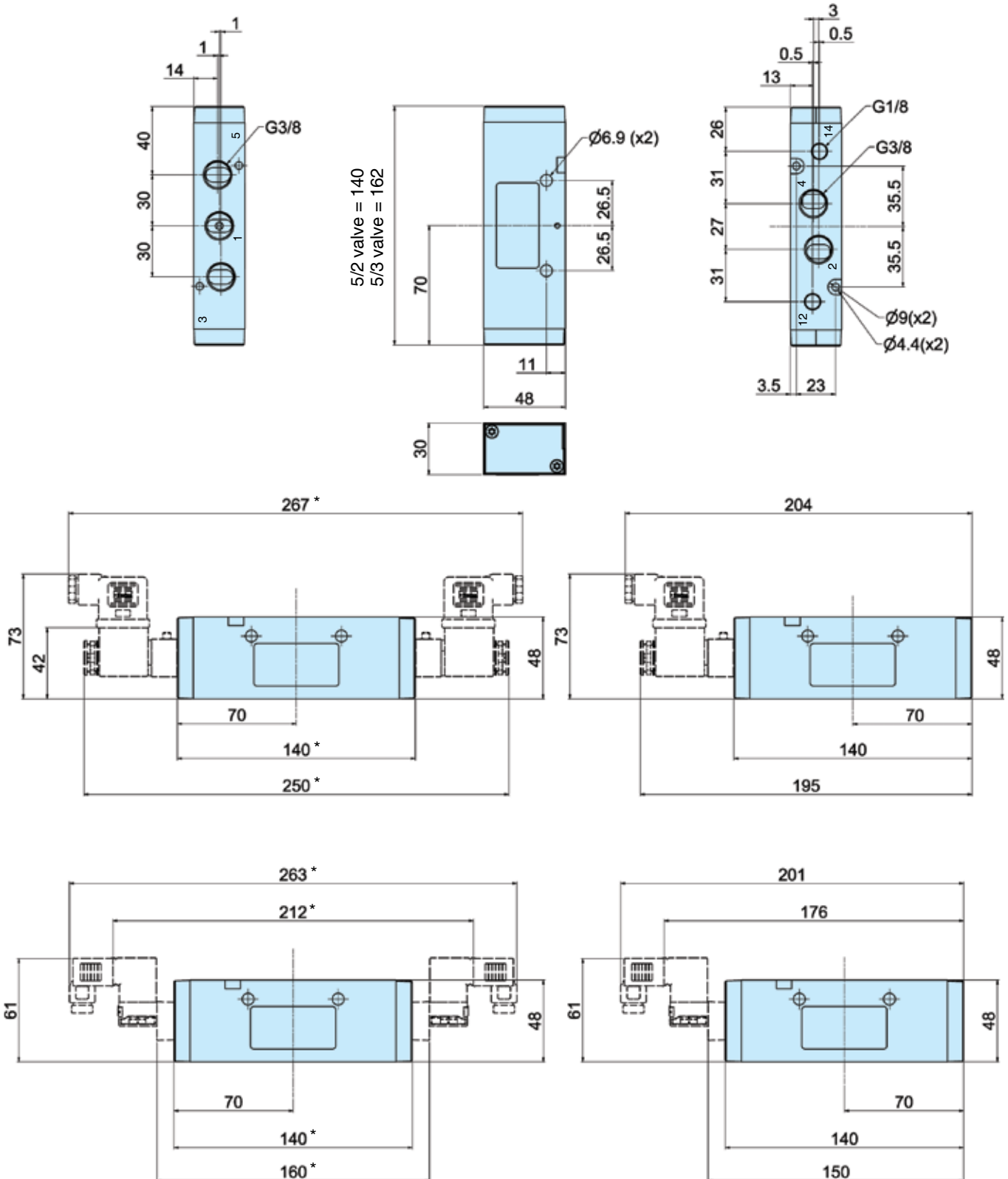

* Note: 5/3 valves - add 22.0mm

Solenoid valves
Solenoid valves and cable plugs must be ordered separately.
One pilot valve is required for each E in the valve order code.

Dimensions

P2LDX... all

5/2 and 5/3 valves

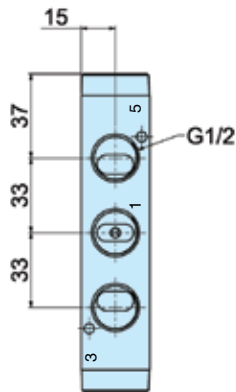

5/2 valve = 140
5/3 valve = 162

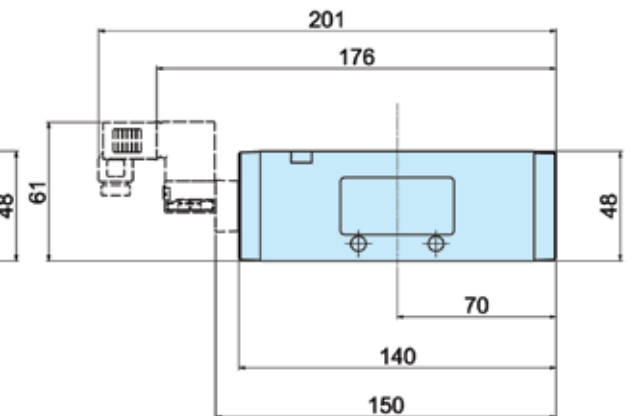
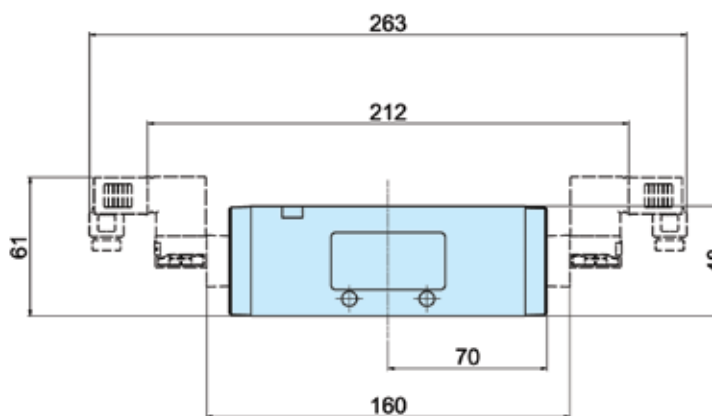
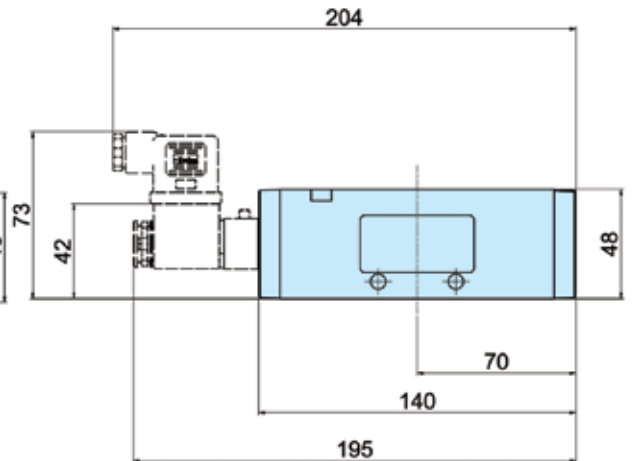
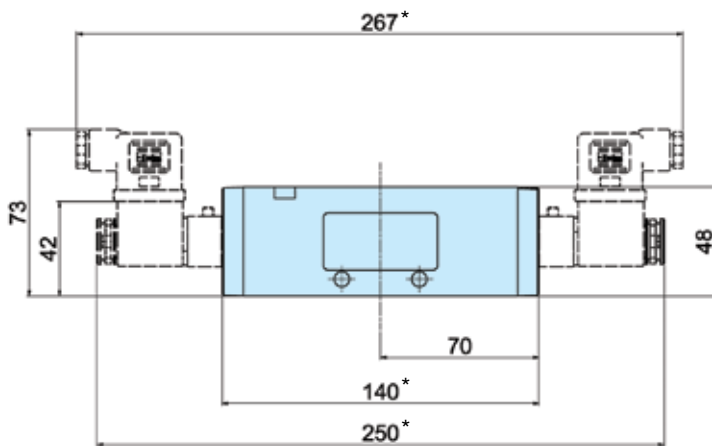
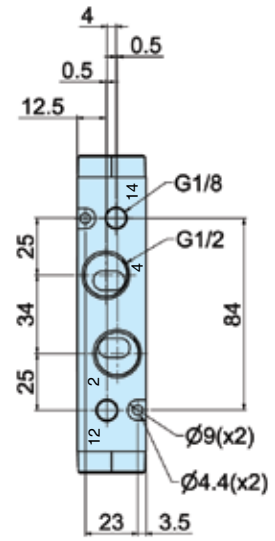
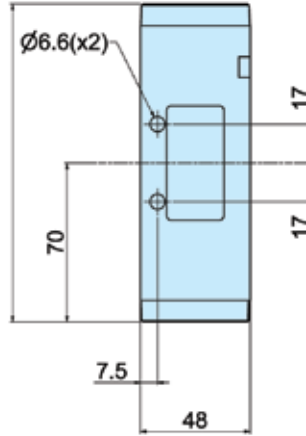

* Note: 5/3 valves - add 22.0mm

Solenoid valves
Solenoid valves and cable plugs must be ordered separately.
One pilot valve is required for each E in the valve order code.

P2LAX, flexible manifold assembly

A practical system solution with the aid of connection pieces. The manifolds can easily be assembled from the top to form a compact and stable block. The block can then be installed in cabinets or directly on the machine frame as shown in the example in the bottom of this page.

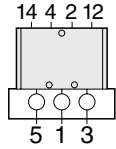

Valve:
with cylinder ports 2 and 4 and signal ports 12 and 14 facing upwards, enabling easily access to connection ports. All ports are G1/8 threaded to simplify choice of connectors.

Manifold:
with common channels for ports 1, 3 and 5.

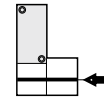

Connection block S:
straight connection block with a side ports for common air supply and exhaust.

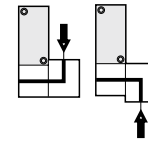

Connection block L:
angled connection block for top or bottom ported.

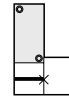

End cover

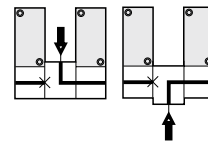
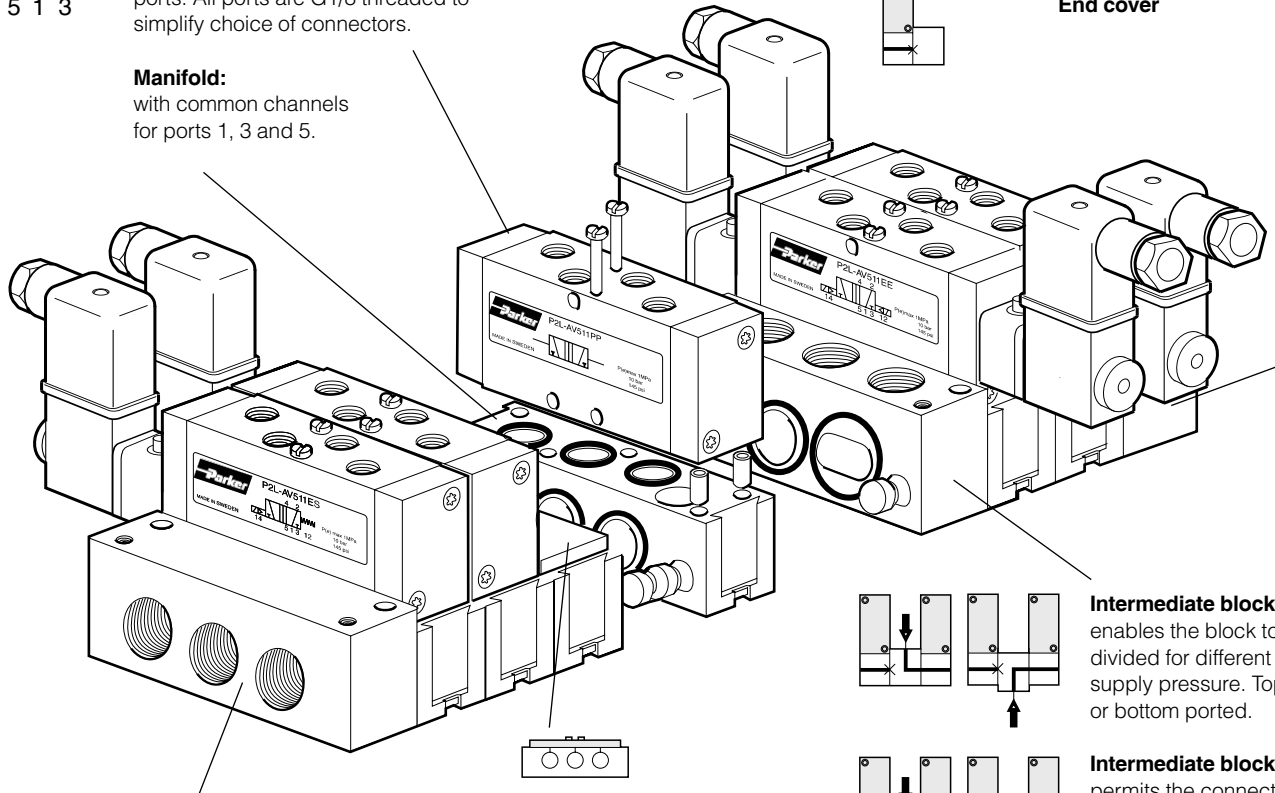

Intermediate block L:
enables the block to be divided for different supply pressure. Top or bottom ported.

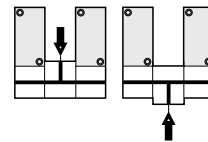

Intermediate block T:
permits the connection of air between two manifolds. Top or bottom ports.

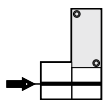

Connection block S:
straight connection block with a side ports for common air supply and exhaust.

Blanking plate:
To incorporate spare positions.

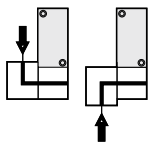



Connection block L:
angled connection block for top or bottom ported.

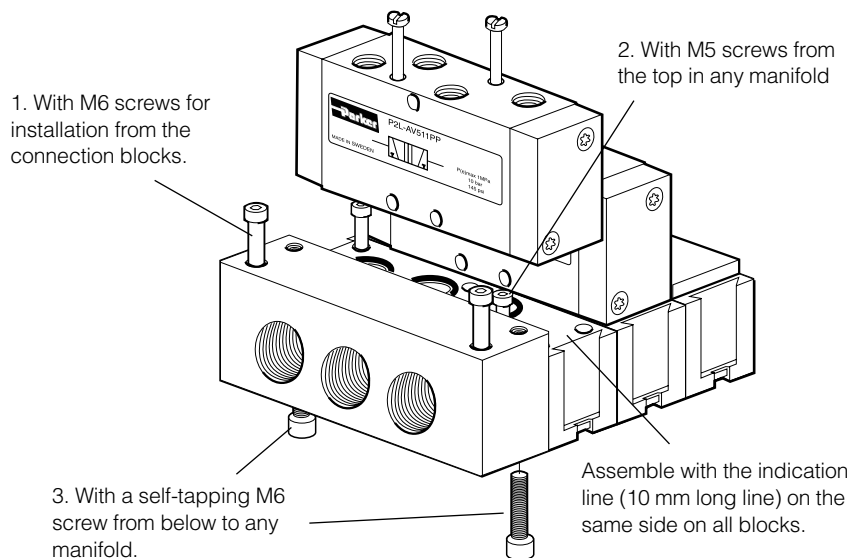

End cover

Various mounting options

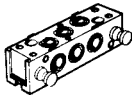
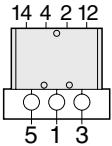
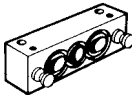
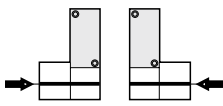
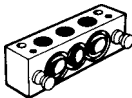
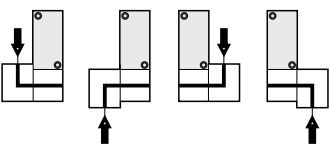
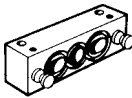
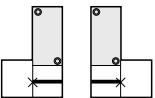
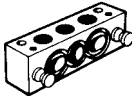
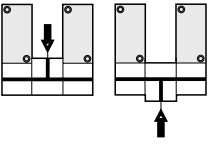
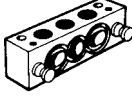
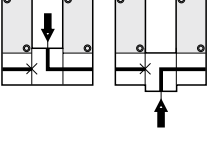

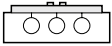
Accessories P2LA	Connection alternatives	Type	Weight kg	Order code
		Multiple manifold including seals, mounting screws, and guiding pins.	0,11	9121658060
		Connection block S including seals, mounting screws, and guiding pins. G1/4	0,15	9121658064
		Connection block L including seals, mounting screws, and guiding pins. G1/4	0,15	9121658061
		End cover including seals, mounting screws, and guiding pins.	0,16	9121658066
		Intermediate block T including seals, mounting screws, and guiding pins. G1/4	0,17	9121658062
		Intermediate block L including seals, mounting screws, and guiding pins. G1/4	0,17	9121658065
		Blanking plate including seals, mounting screws.	0,05	9121658063





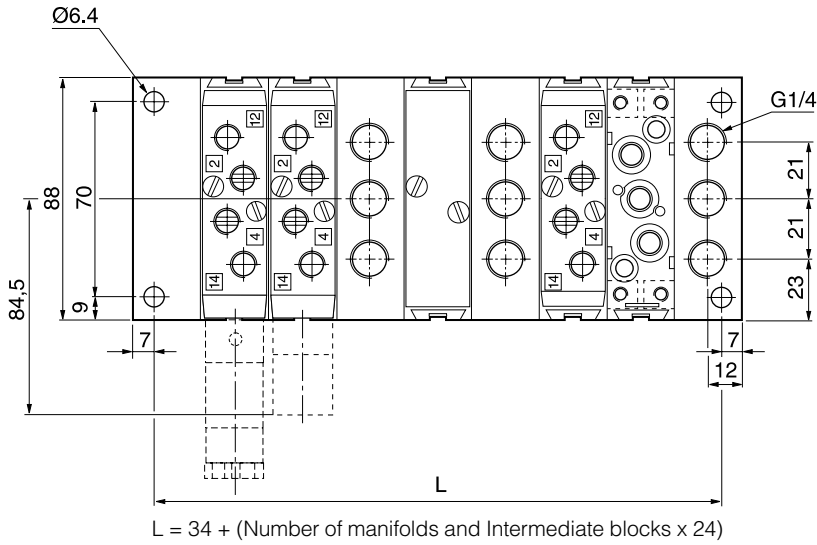

Mounting screws in stainless steel for valve and blanking plate, see page 31

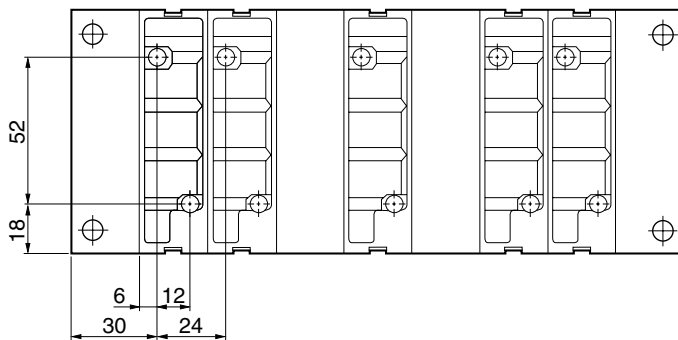
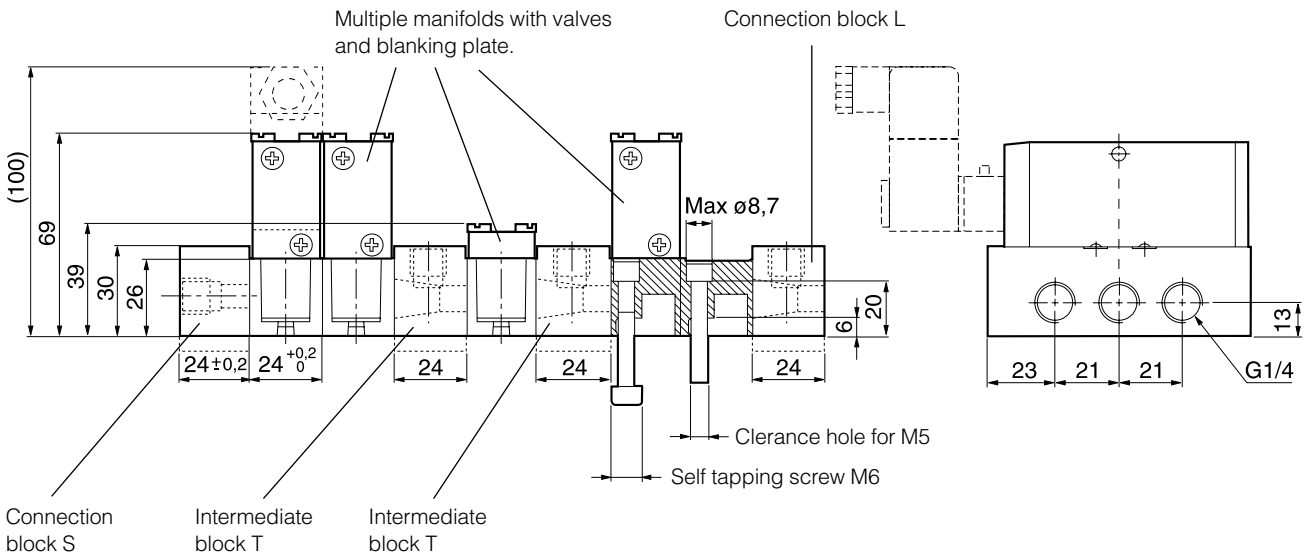
Dimensions

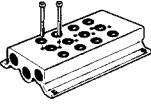

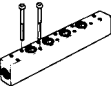
Connection block L and intermediate blocks L and T can be turned so that connection can be made from above or below.
 Multiple manifolds must be fitted with the top indication line (a 10 mm long line) facing the same side on all manifolds.



Accessories P2LA	Type	Weight kg	Order code
	Manifold bar, P2LA including seals, mounting screws. G3/8 For 4 valves For 6 valves For 8 valves For 10 valves For 12 valves For 14 valves	0,48 0,63 0,80 0,98 1,10 1,23	9121658075 9121658076 9121658077 9121658078 9121658079 9121658099
	Blanking plate, P2LA for Manifold bar	0,05	9121658063
	Pressure bar, P2LA for common air supply incl. O-rings and mounting screws. G1/4 For 2 valves For 4 valves For 6 valves For 8 valves	0,13 0,20 0,26 0,33	9121658070 9121658071 9121658072 9121658073
	Blanking plate, P2LA for Pressure bar	0,05	9121658074
	Assembly screws, P2LA in stainless steel for valve	0,02	9121658043
	Assembly screws, P2LA in stainless steel for blanking plate	0,01	9121658044
	O-ring kit, P2LA O-rings between valve and manifold bar/Pressure bar	0,01	9121658046

Dimensions

Manifold bar, P2LA

No. of valves	L mm
4	126
6	174
8	222
10	270
12	318
14	366

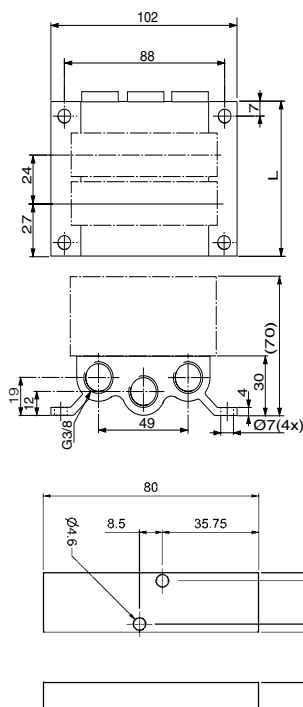

**Blanking plate
 for manifold bar,
 P2LA**

Pressure bar, P2LA

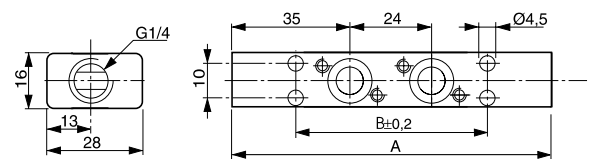

Blanking plate for pressure bar, P2LA

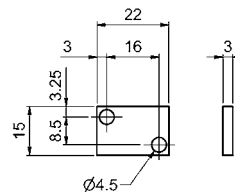

No. of valves	A mm	B mm
2	94	56
4	142	104
6	190	152
8	238	200

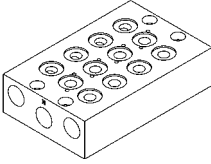
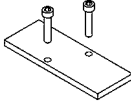
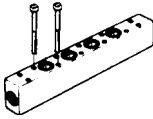
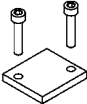
Accessories P2LB	Type	Weight kg	Order code
	Manifold bar, P2LB, (not for P2LB with external air supply to solenoid valves) incl. fasteners and O-ring. G3/8 For 2 valves For 4 valves For 6 valves For 8 valves For 10 valves	0,69 1,13 1,56 2,00 2,45	9121594805X 9121594806X 9121594807X 9121594808X 9121594812X
	Blanking plate, P2LBX for Manifold bar	0,10	9121594809X
	Pressure bar, P2LBX for common air supply incl. O-rings and mounting screws. G3/8 For 2 valves For 4 valves For 6 valves For 8 valves For 10 valves	0,38 0,53 0,68 0,83 0,99	9127113301X 9127113302X 9127113303X 9127113304X 9127113305X
	Blanking plate P2LBX for Pressure bar. G1/4	0,02	9127113306X

Dimensions

Manifold bar, P2LB

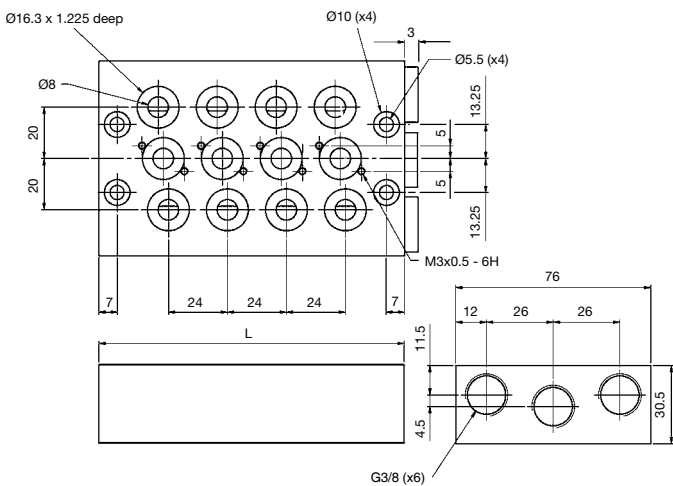

No. of valves	L mm
2	74
4	122
6	170
8	218
10	266

Blanking plate for manifold bar, P2LB

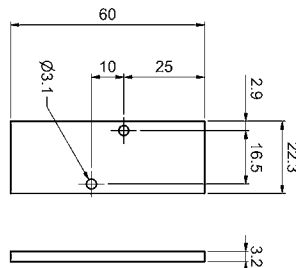

Pressure bar, P2LB

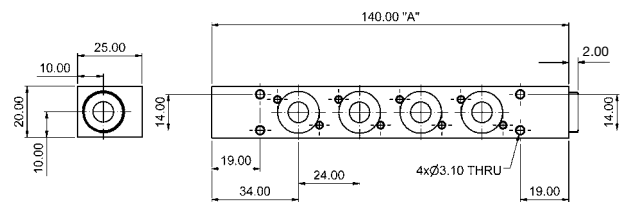

Blanking plate for pressure bar, P2LB

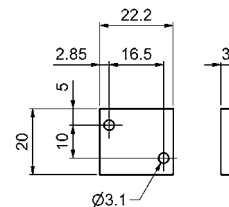

No. of valves	A mm
2	92
4	140
6	188
8	236
10	284

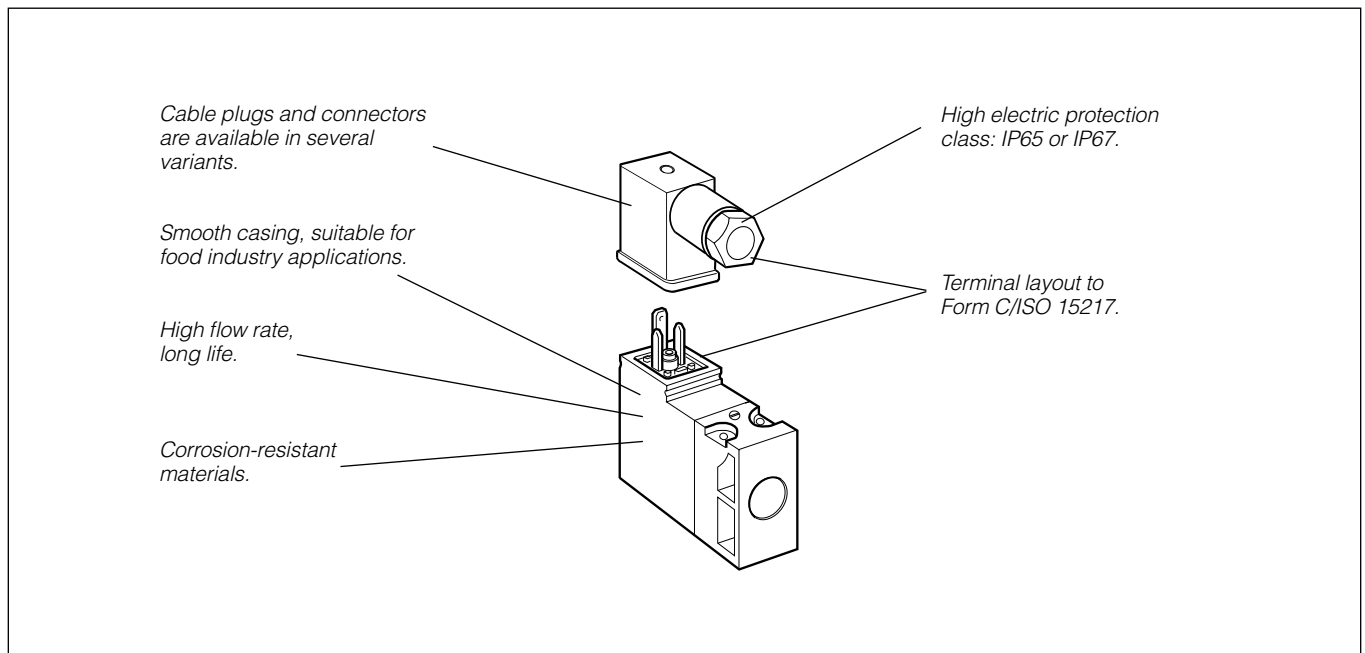

The P2E-•V solenoid operator range

The P2E-•V range of operators are normally closed (NC) 3/2 solenoid valves, with exceedingly compact dimensions in relation to their capacity.

International standard

The port connection pattern complies with a new French CNOMO standard (in process of drafting), with cable plug connections in accordance with Form C/ISO15217.

Compact design

Overall dimensions of the P2E-•V operators are substantially less than those of earlier generations of solenoid operators.

High flow capacity

High flow capacity relative to the electrical operating power as a result of optimised internal flow paths.

Corrosion-resistant design

The valve is made of thermoplastic material and stainless steel, with Viton™ and nitrile rubber seals for excellent corrosion resistance.

Clean lines suitable for food industry applications, P2E-QV

The valve has been designed in conjunction with several machine manufacturers and organisations in the food processing industry, with corrosion-resistant materials and smooth lines being important starting points. The valve and its accessories have been designed so that there are no gaps or crevices in which dirt could collect.

High reliability

Few moving parts result in high reliability, rapid changeover and very long life.

Low power demand

The solenoids have a power demand of 1.2 W at 24 V DC and 1.6 VA at 24 V AC, 115 V AC and 230 V AC.

High protection class

The protection class is IP 65 when connected using the cable plug with a moulded cable. When using the standard cable plug for fitting by the user, the protection class is IP65, the bare valve, with Fast-on connectors, has an encapsulation class of IP 20.

Insensitive to dirty air

The use of generously sized flow paths (1.0 mm diameter) means that the valve can be used in normal industrial environments without problems of blocking.

Manual override as option

The operators can be supplied with or without manual override. The manual override device is available as a screwdriver groove or with a control arm, and is either spring return (blue) or lockable (yellow).

Order key, solenoid operators (15mm)

P	2	E	-	Q	V	3	2	C	3
----------	----------	----------	----------	----------	----------	----------	----------	----------	----------

Valve family	
P2E	Solenoid operator

Subfamily	
Solenoid operator, 15 mm wide Electric connection acc. to ISO 15217 Form C EI/supply connection on opposite side	
K	Standard version
M	Mobile version
Q	Food industry version

Type of current	
1	AC 50 Hz
2	DC
4	AC 50/60 Hz
5	Mobile and wide band only

Voltage	
B	12 V
C	24 V
D	48 V
F	115 V*
J	230 V*
W	37,5 V**
T	72 V**
Y	78 V**
V	96 V**
E	110 V**

Overrides	
0	Without
1	Non locking (blue)
2	Locking (yellow)
3	Extended non locking (blue)
4	Extended locking (yellow)

Valvetype/Function	
3	 3/2 valve, normally closed (NC)

* For standard and food type only
** For mobile "M" version only

Technical data

	NC, Standard	NC, Food ¹⁾	NC, Mobile ²⁾
Working pressure	0 to 10 bar	0 to 10 bar	0 to 10 bar
Working temperature	-15 °C to +60 °C	-15 °C to +60 °C	-40 °C to +70 °C
Orifice	1,0 mm	1,0 mm	1,0 mm
Flow Qmax	33 NI/min	33 NI/min	22 NI/min
Power, hold	DC 1,2 W / AC 1,6 VA	DC 1,2 W / AC 1,6 VA	DC 1 W
Power, surge	DC 1,2 W / AC 3,5 VA	DC 1,2 W / AC 3,5 VA	DC 1 W
Connection time	100%	100%	100%
Voltage tolerance	+10%/–15%	+10%/–15%	+25%/–30%
Electric connection:	Form C/ISO15217		
Port pattern:	To future CNOMO standard		
Protection:	IP 65		
Approval:	Some valves are UL 429 recognised and marked with the following symbol		
Working media:	All neutral media, such as compressed air, water, hydraulic oil and many gases.		
1) Design:	Completely smooth exterior, suitable for food industry.		
2) Mobile standard	According to European standard EN 50 155.		

Transients

Interrupting the current through the solenoid coil produces momentary voltage peaks which, under unfavourable conditions, can amount to several hundred times the rated operating voltage. Normally, these transients do not cause problems, but to achieve the maximum life of relays in the circuit (and particularly of transistors, thyristors and integrated circuits) it is desirable to provide protection by means of voltage-dependent resistors (varistors). All cable plugs with a yellow LED also incorporate such protection.

Service life

With compressed air at 6 bar, 20 °C and complying with the requirements for compressed air quality as set out in ISO8573-1 norm (class 4 for dry and class 5 for filtered air), the valves should have a life of at least 50 million cycles.

Materials

Operator

Body, coil casing	Thermoplastic
Internal metal parts	Steel
Screws	Stainless steel
Bottom plug	Thermoplastic
Sealing materials	FPM (Viton™) and nitrile rubber

Cable head

Sheath	Thermoplastic
Retaining screw	Stainless steel, zinc-plated steel

15mm Solenoid Operators

Electrical connection EN175301-803 C/ISO15217 (Ex DIN 43650C)

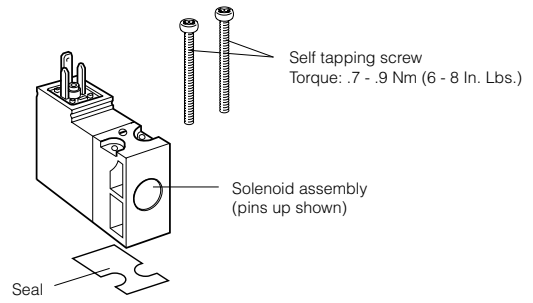

Solenoids 15 mm NC, standard

(Note! Mounting screws included in basic valve)

	Voltage	Weight Kg	Order code Without manual override	Weight Kg	Order code Override, blue, non locking flush	Weight Kg	Order code Override, yellow, locking flush
	12 VDC	0,038	P2E-KV32B0	0,038	P2E-KV32B1	0,038	P2E-KV32B2
	24 VDC	0,038	P2E-KV32C0	0,038	P2E-KV32C1	0,038	P2E-KV32C2
	48 VDC	0,038	P2E-KV32D0	0,038	P2E-KV32D1	0,038	P2E-KV32D2
	24 VAC 50Hz	0,038	P2E-KV31C0	0,038	P2E-KV31C1	0,038	P2E-KV31C2
	48 VAC 50/60Hz	0,038	P2E-KV34D0	0,038	P2E-KV34D1	0,038	P2E-KV34D2
	115 VAC 50Hz/ 120 VAC 60Hz	0,038	P2E-KV31F0	0,038	P2E-KV31F1	0,038	P2E-KV31F2
	230 VAC 50Hz/ 240 VAC 60Hz	0,038	P2E-KV31J0	0,038	P2E-KV31J1	0,038	P2E-KV31J2
	Voltage	Weight Kg	Order code Override extended, blue, non locking flush	Weight Kg	Order code Override extended, yellow, locking flush		
24 VDC	0,038	P2E-KV32C3	0,038	P2E-KV32C4			
24 VAC 50Hz	0,038	P2E-KV31C3	0,038	P2E-KV31C4			

Solenoids 15 mm NC, mobile

(Note! Mounting screws included in basic valve)

	Voltage	Weight Kg	Order code Without manual override	Weight Kg	Order code Override, blue, non locking flush
	12 VDC	0,038	P2E-MV35B0	0,038	P2E-MV35B1
	24 VDC	0,038	P2E-MV35C0	0,038	P2E-MV35C1
	37,5 VDC	0,038	P2E-MV35W0	0,038	P2E-MV35W1
	48 VDC	0,038	P2E-MV35D0	0,038	P2E-MV35D1
	72 VDC	0,038	P2E-MV35T0	0,038	P2E-MV35T1
	78 VDC	0,038	P2E-MV35Y0	0,038	P2E-MV35Y1
	96 VDC	0,038	P2E-MV35V0	0,038	P2E-MV35V1
	110 VDC	0,038	P2E-MV35E0	0,038	P2E-MV35E1

Solenoids 15 mm NC, food industry version

(Note! Mounting screws included in basic valve)

	Voltage	Weight Kg	Order code Without manual override	Weight Kg	Order code Override, blue, non locking flush	Weight Kg	Order code Override, yellow, locking flush
	24 VDC	0,038	P2E-QV32C0	0,038	P2E-QV32C1	0,038	P2E-QV32C2
	48 VDC	0,038	P2E-QV32D0	0,038	P2E-QV32D1	0,038	P2E-QV32D2
	24 VAC 50Hz	0,038	P2E-QV31C0	0,038	P2E-QV31C1	0,038	P2E-QV31C2
	48 VAC 50/60Hz	0,038	P2E-QV34D0	0,038	P2E-QV34D1	0,038	P2E-QV34D2
	115 V 50Hz/ 120 V 60Hz	0,038	P2E-QV31F0	0,038	P2E-QV31F1	0,038	P2E-QV31F2
	230 VAC 50Hz/ 240 VAC 60Hz	0,038	P2E-QV31J0	0,038	P2E-QV31J1	0,038	P2E-QV31J2
	Voltage	Weight Kg	Order code Override extended, blue, non locking flush	Weight Kg	Order code Override extended, yellow, locking flush		
	24 VDC	0,038	P2E-QV32C3	0,038	P2E-QV32C4		
24 VAC 50Hz	0,038	P2E-QV31C3	0,038	P2E-QV31C4			
115 VAC 50 Hz	0,038	P2E-QV31F3	0,038	P2E-QV31F4			
230 VAC 50 Hz	0,038	P2E-QV31J3	0,038	P2E-QV31J4			

In accordance with the EU Machine Directive, EN 983, solenoid valves with manual override should have spring-return operating arms for safety.

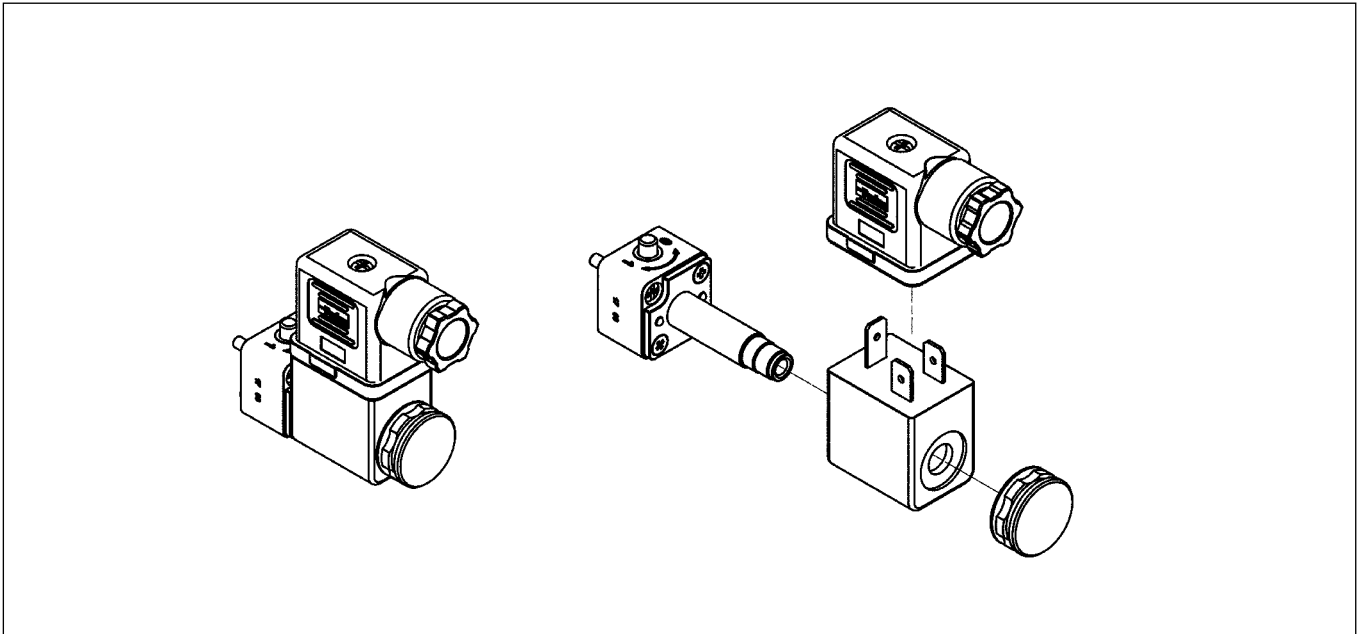

22mm Solenoid pilot options

The P2F P13*4* (NC) 3/2 solenoid pilot operators are designed for piloting pneumatic control valves with compressed air or other inert gases.

The P2F P operator is available for Normal operating pressures up to 10 bar having an outlet orifice 1.3mm and exhaust orifice 1.5 mm. An alternative operator is also available having an outlet orifice of 0.8mm and exhaust orifice of 1.0mm for Xtreme maximum operating pressure of 16 bar and wide band voltage tolerances required for mobile applications.

Corrosion resistant design

The pilot operator body is manufactured in thermoplastic PA 6 material and the core tube brass/stainless steel. The plunger/core is made from stainless steel and the valve seats from FKM.

Solenoid Pilot Exhaust

These operators all exhaust out of the top of the core tube which is tapped M5. The standard solenoid nut fitted to the core tube is the Diffuser nut which allows the exhaust to escape to atmosphere. This nut also minimises ingress of dirt into the valve through this port. The alternative plastic knurled nut can be specified (refer to part number system) if the exhaust air needs to be captured and piped away using the M5 tapped port.

Coils

Coils are wound with enameled copper wire, having temperature index 180°C with class F insulation (155°C) and are encapsulated in Thermoplastic resin. When fitted with suitable connector and correct gasket they give protection to IP65.

Mobile Applications

Viking Xtreme valves are tested to +5g shock and vibration. Solenoid operated valves are designed to operate with wide voltage tolerance bands within the ambient temperature ranges stated in the technical section.

Manual Override options

The pilot operators can be supplied with or without manual override. The standard manual override is the monostable (spring return) extended brass override. Alternatively the bistable (locking) override can be specified as an alternative for the Normal duty 10bar option.

Spares

Solenoid operators are available as spares complete with mounting screws and seals. Coils and connectors should be ordered separately.

Order key, solenoid operators (22mm)

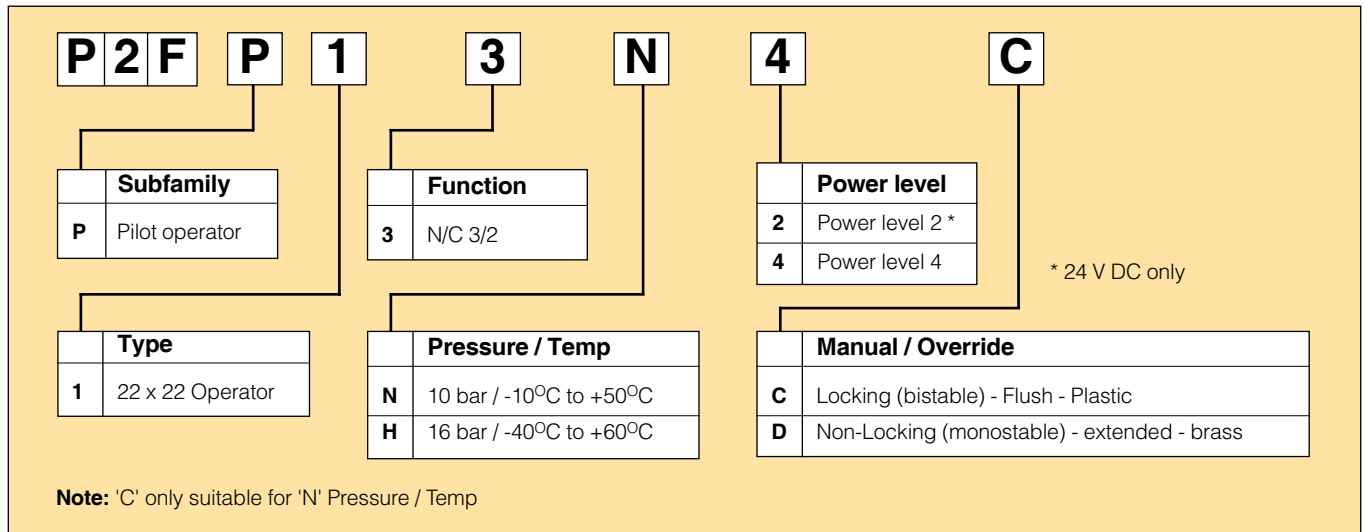

Technical data

	NC Normal	NC Xtreme	NC 22mm Xtreme (Mobile)	NC 30mm Xtreme (Mobile)
Working pressure	0 to 10 bar	0 to 16 bar	0 to 10 bar	0 to 16 bar
Ambient temperature	-10 °C to +50 °C	-40 °C to +60 °C	-40 °C to +60 °C	-40 °C to +60 °C
Orifice	1.3/1.5mm	0.8/1.0mm	0.8/1.0mm	0.8/1.0mm
Flow Qn @ 6 bar input				
1 bar press drop. 1-2 l/m	55	20	20	20
Flow Qn @ 6 bar input				
1 bar press drop. 2-3 l/m	70	30	30	30
Power (DC)	4.8W (2W Low power)	4.8W	6.0W	6.8W
Power (AC)	8.5VA	8.5VA		
Voltage tolerance (Standard)	+/- 10%	+/- 10%		
Voltage tolerance (Mobile)			-10 to +30%	+/- 30%
Duty cycle	100%	100%	100%	100%
Insulation class	F	F	F	F
Electric connection	Ind Form B	Ind Form B	Ind Form B	Form A
Protection	IP65	IP65	IP65	IP65
Shock & Vibration	-	0 to +5g	0 to +5g	0 to +5g
Approval	UL coil version available on request			
Working media	All neutral media such as compressed air and inert gases.			

Mobile applications

Solenoid operated Viking Xtreme duty valves for Mobile applications are fitted with the P2FP13H4D solenoid pilot operator. It has a 22mm footprint with 0.8/1.0mm orifice and will accept 22mm or 30mm coil options. The choice of coil option will depend on the voltage tolerance, operating ambient temperature range and maximum operating pressure. Use the technical data in the table above before selecting the coil type required, or contact our technical department.

Transients

Interrupting the current through the solenoid coil produces momentary voltage peaks which, under unfavourable conditions, can amount to several hundred times the rated operating voltage. Normally, these transients do not cause problems, but to achieve the maximum life of relays in the circuit (and particularly of transistors, thyristors and integrated circuits) it is desirable to provide protection by means of voltage-dependent resistors (varistors). All connectors/cable plugs with LED's listed on page 34 include this type of circuit protection.

Materials

Pilot Valve

Body:	Polyamide
Armature tube:	Brass (Normal) Stainless Steel 16 bar mobile
Plunger & core:	Corrosion resistant Cr-Ni steel
Seals:	FKM (Viton™)
Screws:	Stainless steel

Coil

Encapsulation material: Thermoplastic

22mm solenoid operator part numbers and spares

Solenoid coils for 22mm solenoid operators

Voltage	Order code Form A	Weight (Kg)	Order code Form B	Weight (Kg)
12V 60Hz			P2FCB440	0.093
24V 50/60Hz			P2FCB442	0.093
12V DC			P2FCB445	0.093
12V DC Mobile	P2FCA447	0.17	P2FCB447	0.093
24v DC Mobile	P2FCA448	0.17	P2FCB448	0.093
24V DC			P2FCB449	0.093
24V DC Low power			P2FCB249	0.093
48V DC			P2FCB451	0.093
110V/50Hz, 120V/60Hz			P2FCB453	0.093
230V/50Hz, 230V/60Hz			P2FCB457	0.093

Note: Mobile solenoids are only suitable for Viking Xtreme valves with 'H' specification having 0,8/1,0 operator type P2FP13H4D

Spare Solenoid Nuts

Valves requiring captured exhaust should be fitted with plastic knurled nut

Order code
P2FNP

Valves with vented exhaust are fitted with diffuser plastic nut

Order Code
P2FND

Spare Solenoid Operators

Solenoid pilot operator 22mm NC, Normal duty
(Max Operating pressure 10bar, Temp -10°C to +50°C)

Order code (with locking bi-stable m/o)	weight Kg	Order code (with Non-locking monostable m/o)	weight Kg
P2FP13N4C	0.05kg	P2FP13N4D	0.05kg

Low power pilot operator NC, Normal duty
(Max Operating pressure 10bar, Temp -10°C to +50°C)

Order code (with locking bi-stable m/o)	weight Kg	Order code (with Non-locking monostable m/o)	weight Kg
P2FP13N2C	0.05kg	P2FP13N2D	0.05kg

Solenoid pilot operator 22mm NC, Xtreme duty
(Max Operating pressure 16bar, Temp -40°C to +60°C)



Order code (with Non-locking monostable m/o)	weight Kg
P2FP13H4D	0.05kg

Note.

Solenoid pilot operators are fitted to the Viking valve range. Order the above part numbers for spares. The operators are supplied with mounting screws and interface 'O' rings.

Coils and connectors must be ordered separately.

Solenoid Connectors / Cable Plugs EN175301-803

	Description	Order code 15mm Form C/ISO15217	Order code 22mm Industrial Form B	Order code 30mm Form A/ISO4400
With large headed screw suitable for mounting in inaccessible or recess position 	Standard IP65	P8C-C		
	24V DC LED and protection IP65	P8C-C26C		
	110V AC LED and protection IP65	P8C-C21E		
With standard screw 	Standard IP65 without flying lead	P8C-D	3EV10V10	3EV290V10
	With LED and protection 24V AC/DC	P8C-D26C	3EV10V20-24	3EV290V20-24
	With LED and protection 110V AC	P8C-D21E	3EV10V20-110	
	With LED and protection 230V AC		3EV10V20-230	
With cable 	Standard with 2m cable IP65	P8L-C2		
	Standard with 5m cable IP65	P8L-C5		
	24V AC/DC, 2m cable LED and protection IP65	P8L-C226C		
	24V AC/DC, 5m cable LED and protection IP65	P8L-C526C	3EV10V20-24L5	3EV290V20-24L5
	24V AC/DC, 10m cable LED and protection IP65	P8L-CA26C		
	110V AC/DC, 2m cable LED and protection IP65	P8L-C221E		
	110V AC/DC, 5m cable LED and protection IP65	P8L-C521E	3EV10V20-110L5	
	230V AC, 5m cable LED and protection IP65		3EV10V20-230L5	

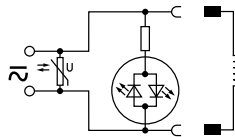
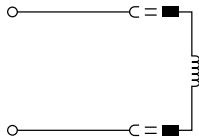

P8C-C
P8C-D
P8L-C2
P8L-C5
3EV10V10

P8C-D26C	P8L-C226C
P8C-D21E	P8L-C526C
P8C-C26C	P8L-CA26C
P8C-C21E	P8L-C221E
	P8L-C521E
3EV10V20-24	3EV10V20-24L5
3EV10V20-110	3EV10V20-110L5
3EV10V20-230	3EV10V20-230L5

Cable Plug Dimensions (mm)

Solenoid operators P2E-V...

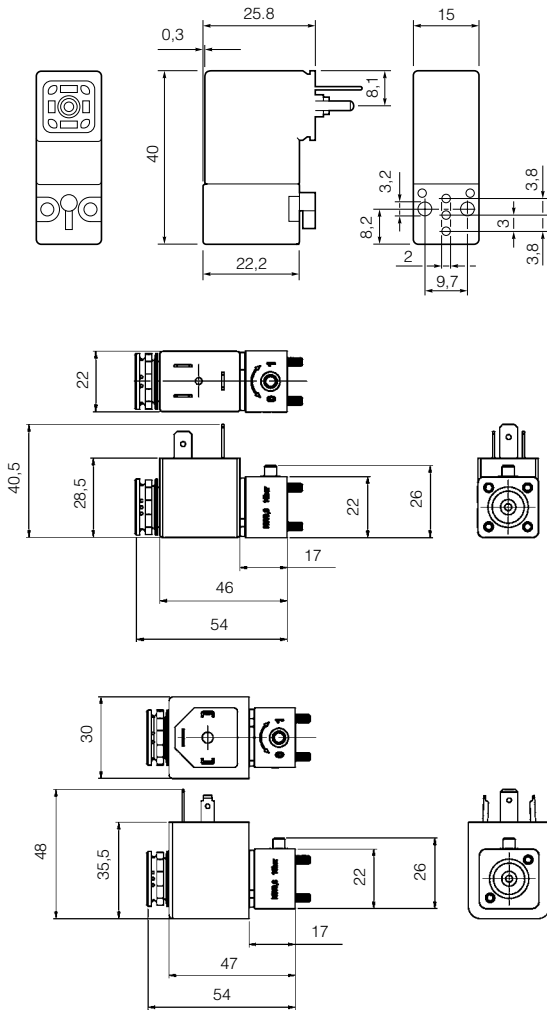

Cable plugs with cables

- P8C-C
- P8C-C26C
- P8C-C21E
- P8C-D
- P8C-D26C
- P8C-D21E

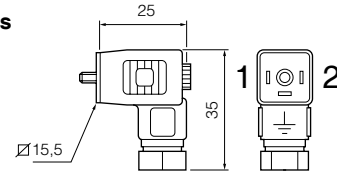

Cable plugs

- P8L-C2
- P8LC5
- P8L-C226C
- P8L-C526C
- P8L-CA26C
- P8L-C221E
- P8L-C521E

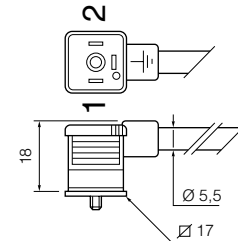

Cable plugs Form B

- 3EV10V10

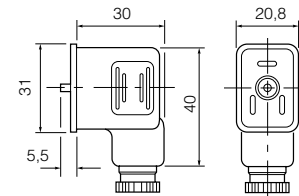

Cable plugs Form A

- 3EV290V10

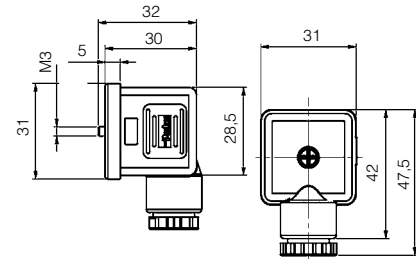

Accessories

Sintered bronze series

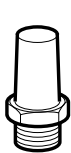

Port	Order code	Pack Qty
M5	9721900005	1
G1/8	9090050700	1
G1/4	P6M-BAA2	1
G3/8	9090050900	1
G1/2	9090051000	1

Male straight connectors - Parallel thread

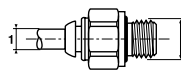

Tube Ø1	Thread B	Order code	Box Qty
4	1/8	F4PMB4-1/8	20
6	1/8	F4PMB6-1/8	30
6	1/4	F4PMB6-1/4	30
8	1/8	F4PB8-1/8	40
8	1/4	F4PB8-1/4	30
8	3/8	F4PB8-3/8	20
10	1/4	F4PB10-1/4	20
10	3/8	F4PB10-3/8	20
10	1/2	F4PB10-1/2	10
12	1/4	F4PB12-1/4	10
12	3/8	F4PB12-3/8	10
12	1/2	F4PB12-1/2	10
14	3/8	F4PB14-3/8	10
14	1/2	F4PB14-1/2	10

Parker Worldwide

AE – UAE, Dubai
Tel: +971 4 8127100
parker.me@parker.com

AR – Argentina, Buenos Aires
Tel: +54 3327 44 4129

AT – Austria, Wiener Neustadt
Tel: +43 (0)2622 23501-0
parker.austria@parker.com

AT – Eastern Europe, Wiener Neustadt
Tel: +43 (0)2622 23501 900
parker.easteurope@parker.com

AU – Australia, Castle Hill
Tel: +61 (0)2-9634 7777

AZ – Azerbaijan, Baku
Tel: +994 50 2233 458
parker.azerbaijan@parker.com

BE/LU – Belgium, Nivelles
Tel: +32 (0)67 280 900
parker.belgium@parker.com

BR – Brazil, Cachoeirinha RS
Tel: +55 51 3470 9144

BY – Belarus, Minsk
Tel: +375 17 209 9399
parker.belarus@parker.com

CA – Canada, Milton, Ontario
Tel: +1 905 693 3000

CH – Switzerland, Etoy
Tel: +41 (0) 21 821 02 30
parker.switzerland@parker.com

CL – Chile, Santiago
Tel: +56 2 623 1216

CN – China, Shanghai
Tel: +86 21 5031 2525

CZ – Czech Republic, Klecany
Tel: +420 284 083 111
parker.czechrepublic@parker.com

DE – Germany, Kaarst
Tel: +49 (0)2131 4016 0
parker.germany@parker.com

DK – Denmark, Ballerup
Tel: +45 43 56 04 00
parker.denmark@parker.com

ES – Spain, Madrid
Tel: +34 902 33 00 01
parker.spain@parker.com

FI – Finland, Vantaa
Tel: +358 (0)20 753 2500
parker.finland@parker.com

FR – France, Contamine s/Arve
Tel: +33 (0)4 50 25 80 25
parker.france@parker.com

GR – Greece, Athens
Tel: +30 210 933 6450
parker.greece@parker.com

HK – Hong Kong
Tel: +852 2428 8008

HU – Hungary, Budapest
Tel: +36 1 220 4155
parker.hungary@parker.com

IE – Ireland, Dublin
Tel: +353 (0)1 466 6370
parker.ireland@parker.com

IN – India, Mumbai
Tel: +91 22 6513 7081-85

IT – Italy, Corsico (MI)
Tel: +39 02 45 19 21
parker.italy@parker.com

JP – Japan, Tokyo
Tel: +(81) 3 6408 3901

KR – South Korea, Seoul
Tel: +82 2 559 0400

KZ – Kazakhstan, Almaty
Tel: +7 7272 505 800
parker.easteurope@parker.com

LV – Latvia, Riga
Tel: +371 6 745 2601
parker.latvia@parker.com

MX – Mexico, Apodaca
Tel: +52 81 8156 6000

MY – Malaysia, Shah Alam
Tel: +60 3 7849 0800

NL – The Netherlands, Oldenzaal
Tel: +31 (0)541 585 000
parker.nl@parker.com

NO – Norway, Ski
Tel: +47 64 91 10 00
parker.norway@parker.com

NZ – New Zealand, Mt Wellington
Tel: +64 9 574 1744

PL – Poland, Warsaw
Tel: +48 (0)22 573 24 00
parker.poland@parker.com

PT – Portugal, Leca da Palmeira
Tel: +351 22 999 7360
parker.portugal@parker.com

RO – Romania, Bucharest
Tel: +40 21 252 1382
parker.romania@parker.com

RU – Russia, Moscow
Tel: +7 495 645-2156
parker.russia@parker.com

SE – Sweden, Spånga
Tel: +46 (0)8 59 79 50 00
parker.sweden@parker.com

SG – Singapore
Tel: +65 6887 6300

SK – Slovakia, Banská Bystrica
Tel: +421 484 162 252
parker.slovakia@parker.com

SL – Slovenia, Novo Mesto
Tel: +386 7 337 6650
parker.slovenia@parker.com

TH – Thailand, Bangkok
Tel: +662 717 8140

TR – Turkey, Istanbul
Tel: +90 216 4997081
parker.turkey@parker.com

TW – Taiwan, Taipei
Tel: +886 2 2298 8987

UA – Ukraine, Kiev
Tel: +380 44 494 2731
parker.ukraine@parker.com

UK – United Kingdom, Warwick
Tel: +44 (0)1926 317 878
parker.uk@parker.com

US – USA, Cleveland
Tel: +1 216 896 3000

VE – Venezuela, Caracas
Tel: +58 212 238 5422

ZA – South Africa, Kempton Park
Tel: +27 (0)11 961 0700
parker.southafrica@parker.com

European Product Information Centre

Free phone: 00 800 27 27 5374

(from AT, BE, CH, CZ, DE, DK, ES, FI, FR, IE, IT, NL, NO, PL, PT, RU, SE, UK, ZA)

