



air
water
oil
antifreeze
grease
diesel fuel
kerosene
oxygen-acetylene
lpg-methane
electricity



Hose & cable reel

Catalogue 2008



Table of contents

Series standard hose reels in painted steel

page 5-6

- For air - water - grease - hydraulic oil
- supplied without hose, with rubber hose or polyurethane hose



Series standard hose reels in high quality impact resistant polypropylene

page 7

- For air - water
- supplied without hose, with rubber hose or polyurethane hose



Series standard hose and cable reel in polypropylene or painted steel

page 8

- For air - water - electricity
- supplied with PVC cable and polyurethane hose



Series standard hand crank hose reel

page 9

- For air - water - hydraulic oil
- supplied without hose or with polyurethane hose



Series standard hose reel in painted steel

page 10

- For air - cold water 20 bar
- supplied without hose or with polyurethane hose



Series industrial hose reel in painted steel and stainless steel AISI 304

page 12-17

- For air - cold water 20 bar
 - For water - hot water 130°C 200/400 bar
- supplied without hose, with black synthetic rubber or polyurethane hose



Series industrial hose reel in painted steel and stainless steel AISI 304

page 18-23

- For air - cold water 20 bar
 - For water - hot water 130°C 200/400 bar
- supplied without hose or with blue hygienic rubber hose



Table of contents

Series industrial hose reel in painted steel and stainless steel AISI 304

page 24-27

- For oil - antifreeze and allied products 150 bar
- For grease 600 bar

supplied without hose or with black synthetic rubber hose



Series industrial hose reel in painted steel or stainless steel AISI 304

page 28-29

- For diesel fuel and Kerosene 10 bar

supplied without hose or with black synthetic rubber hose

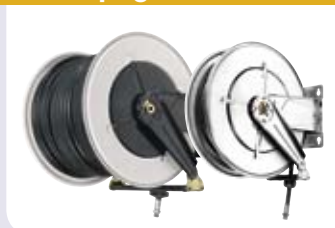

Series industrial hose reel in painted steel or stainless steel AISI 304

page 30-32

- For oxygen and acetylene 20 bar
- For lpg-methane 20 bar

supplied without hose or with hose according to EN 559 specifications

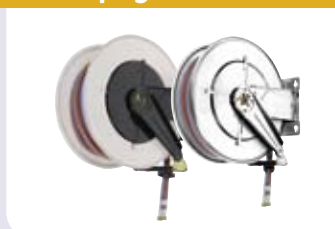

Series industrial hose reels enclosed in painted steel

page 33

- For air - cold water 20 bar
- For oil - antifreeze and allied products 150 bar
- For grease 600 bar

supplied without hose or with black synthetic rubber hose



Series industrial enclosed in shock resistant technopolimer material

page 33

- For air - cold water 20 bar

supplied with polyurethane hose



Series industrial powered hydraulic or pneumatic in painted steel

page 34-38

- For air - water 20 bar
- For water - hot water 130°C 100 bar
- For oil - antifreeze and allied products 150 bar
- For grease 400 bar
- For diesel fuel - Kerosene 10 bar

supplied without hose or with black synthetic rubber hose



Hose capacity per series of reels

Page 39

Fixed and swivelling brackets

Page 40-41

General specifications / overall dimensions

Page 42-43



We are proud to present the new hose- & cable reel catalogue 2008. This catalogue is showing our standard series and our industrial series in a very user-friendly way. This means that all the relevant product information for your application is now quick and easy to find.

Rectus Tema ApS is located in Horsens, Denmark and is a part of the Rectus Group, Germany who is the leading manufacturer of quick disconnect couplings and related products for pneumatic, hydraulic, medical and chemical processing applications.

April 2nd, 2007 - Parker Hannifin, the global leader in motion and control technologies, announced the acquisition of Rectus AG.

I hope that you will enjoy the new catalogue and find that it offers you some useful new ideas!

We are, of course, always available to offer advice and help if you have any further questions or particular requirements that are not covered by our wide range.

Series standard

Air / water / hydraulic

Series 805	Dimension	Length (m)	Hose	Media	Max. Pressure	Inlet	Outlet	Weight	Item	Pack. Dim.(mm)
	3/8"	10	rubber	air/water	20 bar	F 3/8" G	M 3/8" G	16 kg	E805103-N	430x225x465
								3 kg	E800100-N	250x200x140

Specifications

- * Heavy-duty steel construction with corrosion resistant powder coating
- * Solid 1" steel centre support shaft
- * Full flow solid brass swivel joint
- * Multi-position release ratchet spring fully enclosed
- * Four direction non-snap rollers reduce hose wear abrasion
- * Wall, ceiling or floor mount

Series 809	Dimension	Length (m)	Hose	Media	Max. Pressure	Inlet	Outlet	Weight	Item	Pack. Dim.(mm)
	1/4"	10	rubber	air/water	20 bar	F 1/4" G	M 1/4" G	13 kg	E809102	400x180x430
	3/8"	10	rubber	air/water	20 bar	F 3/8" G	M 3/8" G	14 kg	E809103	400x180x430
	10/14,5mm	12	PU	air	20 bar	F 3/8" G	M 3/8" G	15 kg	E809123	400x180x430
								2,5 kg	E800809	250x200x140

Specifications

- * Heavy-duty steel construction with corrosion resistant powder coating
- * Four direction non-snap rollers reduce hose wear abrasion
- * Multi-position ratchet lock and easy tension adjustment
- * Guide arm adjustable for handling up to 9 positions permits wall, ceiling or floor mount

Series 816	Dimension	Length (m)	Hose	Media	Max. Pressure	Inlet	Outlet	Weight	Item	Pack. Dim.(mm)
	10/14,5mm	15	PU	air	20 bar	F 3/8" G	M 3/8" G	13 kg	E816153	460x190x490

Specifications

- * Heavy-duty steel construction with corrosion resistant powder coating
- * Guide arm adjustable for handling up to 9 positions permits wall, ceiling or floor mount
- * PU braided hose





Series 820	Dimension	Length (m)	Hose	Media	Max. Pressure	Inlet	Outlet	Weight	Item	Pack. Dim.(mm)
	3/8"	15	rubber	air/water	20 bar	F 3/8" G	M 3/8" G	22 kg	E820153	500x230x520
	1/2"	15	rubber	air/water	20 bar	F 1/2" G	M 1/2" G	23 kg	E820154	500x230x520
								2,5 kg	E800820	245x195x135

Specifications

- * Heavy-duty steel construction for long life in industrial an automotive applications
- * Reel covered by corrosion resistant powder coating, two supporting arm and base galvanized
- * Dual pedestal base, double supporting 1-3/8" axle, full flow shaft & swivel joint, structurally reinforced
- * Multi position release ratchet, spring fully enclosed and lubricated
- * Four direction non-snap rollers reduce hose wear abrasion
- * Wall, ceiling or floor mount

Series standard

Air / water / hydraulic

Series 801	Dimension	Length (m)	Hose	Media	Max. Pressure	Inlet	Outlet	Weight	Item	Pack. Dim.(mm)	
	3/8"	20	rubber	air/water	20 bar	F 3/8" G	M 3/8" G	22 kg	E801203-N	520x235x560	
	1/2"	20	rubber	air/water	20 bar	F 1/2" G	M 1/2" G	26 kg	E801204-N	520x235x560	
	Swivel bracket 140°								3 kg	E800100-N	245x195x135
	Specifications * Steel construction with corrosion resistant powder coating * Solid 1" steel centre support shaft * Full flow solid brass swivel joint * Multi-position release ratchet spring fully enclosed * Four direction non-s snag rollers reduce hose wear abrasion * Wall, ceiling or floor mount										
Series 808	Dimension	Length (m)	Hose	Media	Max. Pressure	Inlet	Outlet	Weight	Item	Pack. Dim.(mm)	
	3/8"	20	rubber	air/water	20 bar	F 3/8" G	M 3/8" G	26 kg	E808203	520x235x565	
	1/2"	20	rubber	air/water	20 bar	F 1/2" G	M 1/2" G	31 kg	E808204	520x235x565	
	Swivel bracket 140°								2,5 kg	E800808	245x195x135
	High Pressure										
	3/8"	20	rubber	grease/Hydraulic	276 bar	F 3/8" G	M 3/8" G	35 kg	EH808203-VI	520x235x565	
3/8"	20	without hose	grease/Hydraulic	276 bar	F 3/8" G	-	22 kg	EH808203W/O-VI	520x235x565		
Specifications * Heavy-duty steel construction with corrosion resistant power coating * 7" wide L-Shaped base with groove reinforcement ensures stable support * Multi-position ratchet lock and easy tension adjustment * Guide arm adjustable for handling up to 9 positions permits wall, ceiling or floor mount											
Series 880	Dimension	Length (m)	Hose	Media	Max. Pressure	Inlet	Outlet	Weight	Item	Pack. Dim.(mm)	
	1/2"	30	rubber	air/water	20 bar	F 1/2" G	M 1/2" G	56 kg	E880304	662x340x765	
	3/4"	20	rubber	air/water	20 bar	F 3/4" G	M 3/4" G	58 kg	E880206	662x340x765	
	1"	15	rubber	air/water	20 bar	F 1" G	M 1" G	60 kg	E880158	662x340x765	
	1/2"	30	without hose	air/water	200 bar	F 1/2" G	-	43 kg	EM880304W/O	662x340x765	
	3/4"	20	without hose	air/water	200 bar	F 3/4" G	-	45 kg	EM880206W/O	662x340x765	
	1"	15	without hose	air/water	200 bar	F 1" G	-	47 kg	EM880158W/O	662x340x765	
	Specifications * Heavy-duty steel construction with corrosion resistant powder coating * Four direction non-s snag rollers reduce hose wear abrasion * Spring fully enclosed and lubricated * Guide arm adjustable, floor mount										
Series EW808	Dimension	Length (m)	Hose	Media	Max. Pressure	Inlet	Outlet	Weight	Item	Pack. Dim.(mm)	
	1/4"	20	rubber	oxygen - acetylene	20 bar	F 1/4" G	M 1/4" G	28 kg	EW8082022	552x250x565	
	Specifications * Heavy-duty steel construction with corrosion resistant powder coating * Full flow swivel joint and swivel body are made from drop forging brass * Double "O" ring sealed design prevents leakage * Swivel body and inlet are both permanently identified with machined grooves on the acetylene side to assure proper installation * 36" inlet hose assembly standard										

Series standard

Air / water

Series	Dimension	Length (m)	Hose	Media	Max. Pressure	Inlet	Outlet	Weight	Item	Pack. Dim.(mm)
Series 705	6,5/10mm	10	PU	air	12 bar	F 1/4" G	M 1/4" G	5 kg	E705102	360x180x360
	8/12mm	8	PU	air	12 bar	F 1/4" G	M 1/4" G	5 kg	E705083	360x180x360
Series 701	3/8"	15	rubber	air/water	20 bar	F 3/8" G	M 3/8" G	12,5 kg	E701153	480x230x470
Series 730	3/8"	10	PU	air/water	20 bar	F 3/8" G	M 3/8" G	6 kg	E733103	440x220x410
	3/8"	15	PU	air/water	20 bar	F 3/8" G	M 3/8" G	8 kg	E735153	490x230x460
	3/8"	20	PU	air/water	20 bar	F 3/8" G	M 3/8" G	10 kg	E737203	540x240x520
	1/2"	15	PU	air/water	20 bar	F 1/2" G	M 1/2" G	10 kg	E737154	540x240x520
Series 170	8 /12 mm	15	PU	air	12 bar	F 1/4" G	M 1/4" G	6 kg	171508	415x380x215



Specifications

- * Durable construction-made from high quality impact resistant polypropylene
- * Positive latching mechanism-automatically locks hose at desired length
- * A safety lock-prevents the hose from moving in either direction

Specifications

- * Durable construction-made from high quality impact resistant polypropylene
- * Positive latching mechanism-automatically locks hose at desired length
- * A safety lock-prevents the hose from moving in either direction

Specifications

- * Durable construction-made from high quality impact resistant polypropylene
- * Positive latching mechanism-automatically locks hose at desired length
- * A safety lock-prevents the hose from moving in either direction
- * Integral wall/overhead swivel bracket

Specifications

- * Durable construction-made from high quality impact resistant polypropylene
- * Positive latching mechanism-automatically locks hose at desired length
- * A safety lock-prevents the hose from moving in either direction

Series standard

Air / water / electricity

Series G701	Dimension	Length (m)	Hose	Media	Max. Pressure	Inlet	Outlet	Weight	Item	Pack. Dim.(mm)
	1/2"	20	PVC	water	10 bar	F 3/4" G	coupling	10 kg	EG701204G	480x230x470



Specifications

- * Durable construction-made from high quality impact resistant polypropylene
- * Positive latching mechanism-automatically lock hose at desired length
- * A safety lock-prevents the hose from moving in either direction
- * Integral wall/overhead swivel bracket
- * Include 47" Lead-in hose, and water gun

Series 605	Cable	Length (m)	Cable	Volt (V)	Plug/Socket	⊙	—	Weight	Item	Pack. Dim.(mm)
	3 x 1,5mm ²	10	PVC	230	Schuko	1000	2000	5 kg	EL605103G	320x180x315
	3 x 2,5mm ²	10	PVC	230	Industrial	1000	2000	5 kg	EL605105CE	320x180x315
	3 x 1,5mm ²	15	PVC	230	Schuko	1000	2000	5 kg	EL605153G	320x180x315
	3 x 1,5mm ²	25	PVC	230	Schuko	1000	2000	8 kg	EL605253G	320x180x315
	5 x 1,5mm ²	20	PVC	400	CEE	1000	3000	10 kg	170420	420x375x230



Specifications

- * Tangle-free encased H05VV-F/H07RN-F cord for easy winding & protection during storage
- * Adjustable cable stop, 2-roller non-snag cable guide
- * Wall or ceiling mount with 180° swivels for easy handling
- * IP42, CE & SEMKO approved
- * 170420 - IP20, CE & SEMKO approved

Series 605-N	Cable	Length (m)	Cable	Volt (V)	Plug/Socket	⊙	—	Weight	Item	Pack. Dim.(mm)
	3 x 1,5mm ²	15	PVC	230	Schuko	1000	2300	6 kg	EL605153G-N	320x180x315



Specifications

- * Tangle-free encased H05VV-F/H07RN-F cord for easy winding & protection during storage
- * Spring retractable with latch
- * Adjustable cable stop, 2-roller non-snag cable guide
- * High quality impact resistant polypropylene case
- * Wall or ceiling mount with 180° swivels for easy handling
- * CE & SEMKO approved
- * IP20

Series 493	Dimension	Length (m)	Hose	Media	Max. Pressure	Inlet	Outlet	Weight	Item	Pack. Dim.(mm)
	9,5/13mm	30	PU	air	16 bar	plug	coupling	16 kg	493013	400x390x410







Specifications

- * Heavy-duty steel frame structure
- * Corrosion resistant powder coating
- * Adjustable brake, solid brass swivel

Series standard

Air / water

Series	Dimension	Length (m)	Hose	Media	Max. Pressure	Inlet	Outlet	Weight	Item	Pack. Dim.(mm)
Series 301	1/4"	60	without hose	air/water	200	F 1/4" G	-	7 kg	EH301602	390x280x280
	3/8"	30	without hose	air/water	200	F 3/8" G	-	7 kg	EH301303	390x280x280
 <p>Specifications</p> <ul style="list-style-type: none"> * Heavy-duty steel frame structure. * Corrosion resistant powder coating. * Spring tension brake, solid brass swivel. * Spring loaded lock pin available to prevent hose from de-reeling. * Mounted on floor, wall or workbench. * Brass & stainless steel fluid path. 										
Series 420	3/8"	90	without hose	air/water	200 bar	F 3/8" G	-	15 kg	EH420903	520x430x530
	1/2"	45	without hose	air/water	200 bar	F 1/2" G	-	15 kg	EH420454	520x430x530
 <p>Specifications</p> <ul style="list-style-type: none"> * Designed for industrial applications where longer length of hose is required * Constructed with heavy-duty powder coated steel * Full flow swivel joint folded handling * Open hose slot drum design * Spring loaded lock pin available to prevent hose from de-reeling * Large reeling capacity 										
Series 901	3/8"	60	without hose	air/water	20 bar	F 3/8" G	-	23 kg	EH901603	700x620x500
	1/2"	30	without hose	air/water	20 bar	F 1/2" G	-	23 kg	EH901304	700x620x500
 <p>Specifications</p> <ul style="list-style-type: none"> * Heavy-duty metal tube frame structure * Corrosion resistant powder coating * Solid 8" rubber tyres, removable crank handle * Adjustable feet prevent reel from slipping forward when pulling hose out 										
Series 491	9,5/13mm	30	PU	air	16 bar	plug	coupling	10 kg	491330	340x300x370
 <p>Specifications</p> <ul style="list-style-type: none"> * Universal rotation * Heavy-duty steel frame structure * Corrosion resistant powder coating * Adjustable brake, solid brass swivel * Include 43" lead-in hose, 360° pivot base 										

Series standard

in painted steel
Air / water
20 bar

Swivel: Brass
Seals: Viton
Hose: Polyurethane

Series 270	Dimension	Length (m)	Hose	Flow	Inlet	Outlet	Item
	Without hose	-	-	800 l/min	M 3/8" G	F 3/8" G	I268/10
	10/14,5mm	13	PU	690 l/min	M 3/8" G	M 3/8" G	I268/12
	8/12mm	15	PU	320 l/min	M 3/8" G	M 1/4" G	I268/13
	6/10mm	10	PU	280 l/min	M 3/8" G	M 1/4" G	I268/14
	6/10mm	15	PU	250 l/min	M 3/8" G	M 1/4" G	I268/15

Series 300	Dimension	Length (m)	Hose	Flow	Inlet	Outlet	Item
	Without hose	-	-	800 l/min	M 3/8" G	F 3/8" G	I298/10
	10/14,5mm	15	PU	670 l/min	M 3/8" G	M 3/8" G	I298/12
	8/12mm	18	PU	300 l/min	M 3/8" G	M 1/4" G	I298/13
	13/19mm	8	PU	800 l/min	M 1/2" G	M 1/2" G	I298/14
	13/19mm	12	PU	780 l/min	M 1/2" G	M 1/2" G	I298/15

Series 350	Dimension	Length (m)	Hose	Flow	Inlet	Outlet	Item
	Without hose	-	-	800 l/min	M 3/8" G	F 3/8" G	I348/10
	10/14,5mm	20	PU	650 l/min	M 3/8" G	M 3/8" G	I348/12
	8/12mm	20	PU	280 l/min	M 3/8" G	M 1/4" G	I348/13
	13/19mm	10	PU	780 l/min	M 1/2" G	M 1/2" G	I348/14
	13/19mm	15	PU	760 l/min	M 1/2" G	M 1/2" G	I348/15

Series 430	Dimension	Length (m)	Hose	Flow	Inlet	Outlet	Item
	Without hose	-	-	800 l/min	F 1/2" G	F 1/2" G	I430/10
	13/19mm	10	PU	760 l/min	F 1/2" G	M 1/2" G	I428/11
	13/19mm	15	PU	740 l/min	F 1/2" G	M 1/2" G	I428/12



Fixed and swivelling bracket see page 40-41

Industrial Series in painted steel and stainless steel AISI 304

Series 260

Series 270

Series 300

Series 350

Series 430

Series 440

Series 530

Series 540

Series 560



For air / cold water 20 bar

For water / hot water 130° C - 200 / 400 bar

For oil / antifreeze and allied products 150 bar

For grease 600 bar

For diesel fuel and kerosene 10 bar

For oxygen and acetylene / LPG-methane 20 bar

DELIVERY TIME:

On some industrial models the delivery time can be 3-4 weeks after receipt of order.

Industrial Series

in painted steel
Air / water
20 bar

Swivel: Brass
Seals: Viton
Hose: Polyurethane/Black synthetic rubber



S. 560



S. 430



S. 270

	Dimension	Length (m)	Hose	Flow	Inlet	Outlet	Item
Series 270	Without hose	-	-	800 l/min	F 3/8" G	F 3/8" G	I270/10
	3/8"	10	rubber	710 l/min	F 3/8" G	M 3/8" G	I270/11
	10/14,5mm	13	PU	690 l/min	F 3/8" G	M 3/8" G	I270/12
	8m/12mm	15	PU	320 l/min	F 3/8" G	M 1/4" G	I270/13
Series 300	Without hose	-	-	800 l/min	F 3/8" G	F 3/8" G	I300/10
	3/8"	12	rubber	690 l/min	F 3/8" G	M 3/8" G	I300/11
	10/14,5mm	15	PU	670 l/min	F 3/8" G	M 3/8" G	I300/12
	8/12mm	18	PU	300 l/min	F 3/8" G	M 1/4" G	I300/13
Series 350	Without hose	-	-	800 l/min	F 3/8" G	F 3/8" G	I350/10
	3/8"	18	rubber	660 l/min	F 3/8" G	M 3/8" G	I350/11
	10/14,5mm	20	PU	650 l/min	F 3/8" G	M 3/8" G	I350/12
	8/12mm	20	PU	280 l/min	F 3/8" G	M 1/4" G	I350/13
	3/8"	12	rubber	690 l/min	F 3/8" G	M 3/8" G	I350/14
Series 430	Without hose	-	-	800 l/min	F 1/2" G	F 1/2" G	I430/10
	1/2"	15	rubber	760 l/min	F 1/2" G	M 1/2" G	I430/11
	3/8"	12	rubber	690 l/min	F 1/2" G	M 3/8" G	I430/12
	3/8"	18	rubber	660 l/min	F 1/2" G	M 3/8" G	I430/13
	1/2"	10	rubber	780 l/min	F 1/2" G	M 1/2" G	I430/14
Series 530	Without hose	-	-	800 l/min	F 1/2" G	F 1/2" G	I530/10
	1/2"	20	rubber	750 l/min	F 1/2" G	M 1/2" G	I530/11
	1/2"	25	rubber	740 l/min	F 1/2" G	M 1/2" G	I530/12
Series 540	Without hose	-	-	3000 l/min	F 1" G	F 1" G	I540/10
	3/4"	15	rubber	2800 l/min	F 1" G	M 3/4" G	I540/11
	3/4"	20	rubber	2750 l/min	F 1" G	M 3/4" G	I540/12
	1"	15	rubber	3000 l/min	F 1" G	M 1" G	I540/13
	Without hose	-	-	800 l/min	F 1/2" G	F 1/2" G	I540/15
	1/2"	30	rubber	720 l/min	F 1/2" G	M 1/2" G	I540/16
Series 560	Without hose	-	-	3000 l/min	F 1" G	F 1" G	I560/10
	3/4"	30	rubber	2700 l/min	F 1" G	M 3/4" G	I560/11
	3/4"	35	rubber	2650 l/min	F 1" G	M 3/4" G	I560/12
	3/4"	40	rubber	2600 l/min	F 1" G	M 3/4" G	I560/13
	1"	20	rubber	2950 l/min	F 1" G	M 1" G	I560/14
	1"	30	rubber	2900 l/min	F 1" G	M 1" G	I560/15
	Without hose	-	-	800 l/min	F 1/2" G	F 1/2" G	I560/16
	1/2"	40	rubber	700 l/min	F 1/2" G	M 1/2" G	I560/17
	1/2"	50	rubber	680 l/min	F 1/2" G	M 1/2" G	I560/18
	1/2"	60	rubber	660 l/min	F 1/2" G	M 1/2" G	I560/19



Fixed and swivelling bracket see page 40-41

Industrial Series

in stainless steel AISI 304

Air / water

20 bar

Swivel:

Brass

Seals:

Viton

Hose:

Polyurethane/Black synthetic rubber



S. 560



S. 430



S. 270

	Dimension	Length (m)	Hose	Flow	Inlet	Outlet	Item
Series 270	Without hose	-	-	800 l/min	F 3/8" G	F 3/8" G	I272/10
	3/8"	10	rubber	710 l/min	F 3/8" G	M 3/8" G	I272/11
	10/14,5mm	13	PU	690 l/min	F 3/8" G	M 3/8" G	I272/12
	8m/12mm	15	PU	320 l/min	F 3/8" G	M 1/4" G	I272/13
Series 300	Without hose	-	-	800 l/min	F 3/8" G	F 3/8" G	I302/10
	3/8"	12	rubber	690 l/min	F 3/8" G	M 3/8" G	I302/11
	10/14,5mm	15	PU	670 l/min	F 3/8" G	M 3/8" G	I302/12
	8/12mm	18	PU	300 l/min	F 3/8" G	M 1/4" G	I302/13
Series 350	Without hose	-	-	800 l/min	F 3/8" G	F 3/8" G	I352/10
	3/8"	18	rubber	660 l/min	F 3/8" G	M 3/8" G	I352/11
	10/14,5mm	20	PU	650 l/min	F 3/8" G	M 3/8" G	I352/12
	8/12mm	20	PU	280 l/min	F 3/8" G	M 1/4" G	I352/13
	3/8"	12	rubber	690 l/min	F 3/8" G	M 3/8" G	I352/14
Series 430	Without hose	-	-	800 l/min	F 1/2" G	F 1/2" G	I432/10
	1/2"	15	rubber	760 l/min	F 1/2" G	M 1/2" G	I432/11
	3/8"	12	rubber	690 l/min	F 1/2" G	M 3/8" G	I432/12
	3/8"	18	rubber	660 l/min	F 1/2" G	M 3/8" G	I432/13
	1/2"	10	rubber	780 l/min	F 1/2" G	M 1/2" G	I432/14
Series 530	Without hose	-	-	800 l/min	F 1/2" G	F 1/2" G	I532/10
	1/2"	20	rubber	750 l/min	F 1/2" G	M 1/2" G	I532/11
	1/2"	25	rubber	740 l/min	F 1/2" G	M 1/2" G	I532/12
Series 540	Without hose	-	-	3000 l/min	F 1" G	F 1" G	I542/10
	3/4"	15	rubber	2800 l/min	F 1" G	M 3/4" G	I542/11
	3/4"	20	rubber	2750 l/min	F 1" G	M 3/4" G	I542/12
	1"	15	rubber	3000 l/min	F 1" G	M 1" G	I542/13
	Without hose	-	-	800 l/min	F 1/2" G	F 1/2" G	I542/15
	1/2"	30	rubber	720 l/min	F 1/2" G	M 1/2" G	I542/16
Series 560	Without hose	-	-	3000 l/min	F 1" G	F 1" G	I562/10
	3/4"	30	rubber	2700 l/min	F 1" G	M 3/4" G	I562/11
	3/4"	35	rubber	2650 l/min	F 1" G	M 3/4" G	I562/12
	3/4"	40	rubber	2600 l/min	F 1" G	M 3/4" G	I562/13
	1"	20	rubber	2950 l/min	F 1" G	M 1" G	I562/14
	1"	30	rubber	2900 l/min	F 1" G	M 1" G	I562/15
	Without hose	-	-	800 l/min	F 1/2" G	F 1/2" G	I562/16
	1/2"	40	rubber	700 l/min	F 1/2" G	M 1/2" G	I562/17
	1/2"	50	rubber	680 l/min	F 1/2" G	M 1/2" G	I562/18
	1/2"	60	rubber	660 l/min	F 1/2" G	M 1/2" G	I562/19



Fixed and swivelling bracket see page 40-41

Industrial Series

in painted steel
Water - Hot water max. 130°C
200 bar

Swivel: St. steel AISI 304
Seals: Viton
Hose: Black synthetic rubber

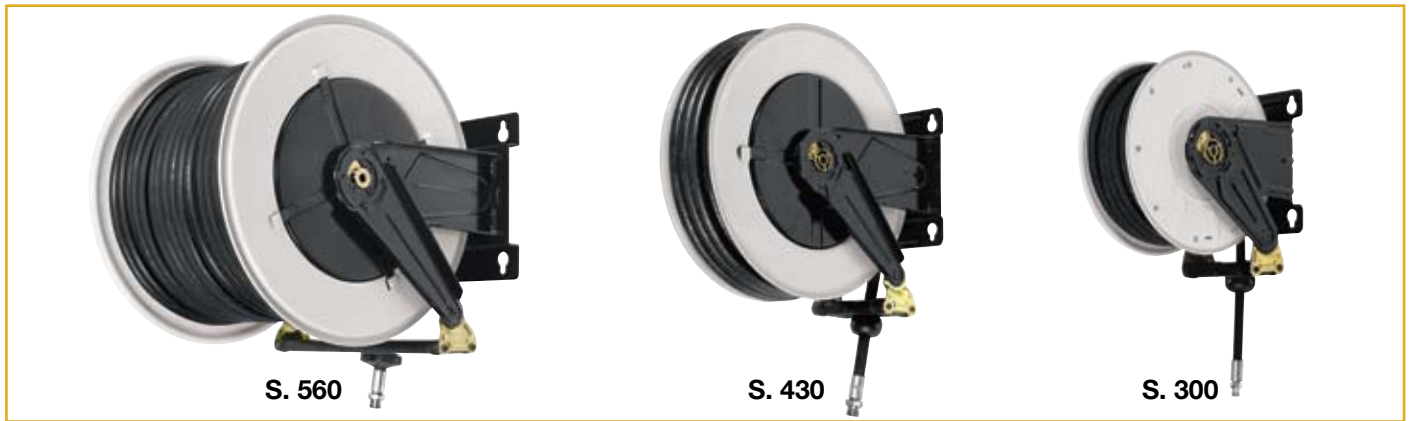

	Dimension	Length (m)	Hose	Flow	Inlet	Outlet	Item
Series 300	Without hose	-	-	30 l/min	F 3/8" G	F 3/8" G	I300/30
	5/16"	12	rubber	25 l/min	F 3/8" G	F 3/8" G	I300/31
Series 350	Without hose	-	-	30 l/min	F 3/8" G	F 3/8" G	I350/30
	5/16"	12	rubber	25 l/min	F 3/8" G	F 3/8" G	I350/31
	5/16"	17	rubber	24 l/min	F 3/8" G	F 3/8" G	I350/32
Series 430	Without hose	-	-	30 l/min	F 3/8" G	F 1/2" G	I430/30
	3/8"	12	rubber	27 l/min	F 3/8" G	F 3/8" G	I430/31
	3/8"	18	rubber	25 l/min	F 3/8" G	F 3/8" G	I430/32
Series 530	Without hose	-	-	30 l/min	F 3/8" G	F 1/2" G	I530/30
	3/8"	25	rubber	24 l/min	F 3/8" G	F 3/8" G	I530/31
	3/8"	20	rubber	25 l/min	F 3/8" G	F 3/8" G	I530/32
Series 540	Without hose	-	-	30 l/min	F 3/8" G	F 1/2" G	I540/30
	3/8"	30	rubber	22 l/min	F 3/8" G	F 3/8" G	I540/31
Series 560	Without hose	-	-	30 l/min	F 3/8" G	F 1/2" G	I560/30
	3/8"	40	rubber	20 l/min	F 3/8" G	F 3/8" G	I560/31
	3/8"	50	rubber	18 l/min	F 3/8" G	F 3/8" G	I560/32



Fixed and swivelling bracket see page 40-41

Industrial Series

in stainless steel AISI 304
Water - Hot water max. 130°C
200 bar

Swivel: St. steel AISI 304
Seals: Viton
Hose: Black synthetic rubber



S. 560



S. 530



S. 300

	Dimension	Length (m)	Hose	Flow	Inlet	Outlet	Item
Series 300	Without hose	-	-	30 l/min	F 3/8" G	F 3/8" G	I302/30
	5/16"	12	rubber	25 l/min	F 3/8" G	F 3/8" G	I302/31
Series 350	Without hose	-	-	30 l/min	F 3/8" G	F 3/8" G	I352/30
	5/16"	12	rubber	25 l/min	F 3/8" G	F 3/8" G	I352/31
	5/16"	17	rubber	24 l/min	F 3/8" G	F 3/8" G	I352/32
Series 430	Without hose	-	-	30 l/min	F 3/8" G	F 1/2" G	I434/30
	3/8"	12	rubber	27 l/min	F 3/8" G	F 3/8" G	I432/31
	3/8"	18	rubber	25 l/min	F 3/8" G	F 3/8" G	I432/32
Series 530	Without hose	-	-	30 l/min	F 3/8" G	F 1/2" G	I534/30
	3/8"	25	rubber	24 l/min	F 3/8" G	F 3/8" G	I532/31
	3/8"	20	rubber	25 l/min	F 3/8" G	F 3/8" G	I532/32
Series 540	Without hose	-	-	30 l/min	F 3/8" G	F 1/2" G	I544/30
	3/8"	30	rubber	22 l/min	F 3/8" G	F 3/8" G	I542/31
Series 560	Without hose	-	-	30 l/min	F 3/8" G	F 1/2" G	I564/30
	3/8"	40	rubber	20 l/min	F 3/8" G	F 3/8" G	I562/31
	3/8"	50	rubber	18 l/min	F 3/8" G	F 3/8" G	I562/32



Fixed and swivelling bracket see page 40-41

Industrial Series

in painted steel
Water - Hot water max. 130°C
400 bar

Swivel: St. steel AISI 304
Seals: Teflon
Hose: Black synthetic rubber



	Dimension	Length (m)	Hose	Flow	Inlet	Outlet	Item
Series 300	Without hose	-	-	40 l/min	F 3/8" G	F 3/8" G	I300/35
	5/16"	12	rubber	38 l/min	F 3/8" G	F 3/8" G	I300/36
Series 350	Without hose	-	-	40 l/min	F 3/8" G	F 3/8" G	I350/35
	5/16"	12	rubber	38 l/min	F 3/8" G	F 3/8" G	I350/36
	5/16"	17	rubber	35 l/min	F 3/8" G	F 3/8" G	I350/37
Series 430	Without hose	-	-	40 l/min	F 3/8" G	F 1/2" G	I430/35
	3/8"	12	rubber	40 l/min	F 3/8" G	F 3/8" G	I430/36
	3/8"	18	rubber	38 l/min	F 3/8" G	F 3/8" G	I430/37
Series 530	Without hose	-	-	40 l/min	F 3/8" G	F 1/2" G	I530/35
	3/8"	25	rubber	38 l/min	F 3/8" G	F 3/8" G	I530/36
	3/8"	20	rubber	35 l/min	F 3/8" G	F 3/8" G	I530/37
Series 540	Without hose	-	-	40 l/min	F 3/8" G	F 1/2" G	I540/35
	3/8"	30	rubber	33 l/min	F 3/8" G	F 3/8" G	I540/36
Series 560	Without hose	-	-	40 l/min	F 3/8" G	F 1/2" G	I560/35
	3/8"	40	rubber	30 l/min	F 3/8" G	F 3/8" G	I560/36
	3/8"	50	rubber	28 l/min	F 3/8" G	F 3/8" G	I560/37



Fixed and swivelling bracket see page 40-41

Industrial Series

in stainless steel AISI 304
Water - Hot water max. 130°C
400 bar

Swivel: St. steel AISI 304
Seals: Teflon
Hose: Black synthetic rubber



S. 560



S. 530



S. 300

	Dimension	Length (m)	Hose	Flow	Inlet	Outlet	Item
Series 300	Without hose	-	-	40 l/min	F 3/8" G	F 3/8" G	I302/35
	5/16"	12	rubber	38 l/min	F 3/8" G	F 3/8" G	I302/36
Series 350	Without hose	-	-	40 l/min	F 3/8" G	F 3/8" G	I352/35
	5/16"	12	rubber	38 l/min	F 3/8" G	F 3/8" G	I352/36
	5/16"	17	rubber	35 l/min	F 3/8" G	F 3/8" G	I352/37
Series 430	Without hose	-	-	40 l/min	F 3/8" G	F 1/2" G	I434/35
	3/8"	12	rubber	40 l/min	F 3/8" G	F 3/8" G	I432/36
	3/8"	18	rubber	38 l/min	F 3/8" G	F 3/8" G	I432/37
Series 530	Without hose	-	-	40 l/min	F 3/8" G	F 1/2" G	I534/35
	3/8"	25	rubber	38 l/min	F 3/8" G	F 3/8" G	I532/36
	3/8"	20	rubber	35 l/min	F 3/8" G	F 3/8" G	I532/37
Series 540	Without hose	-	-	40 l/min	F 3/8" G	F 1/2" G	I544/35
	3/8"	30	rubber	33 l/min	F 3/8" G	F 3/8" G	I542/36
Series 560	Without hose	-	-	40 l/min	F 3/8" G	F 1/2" G	I564/35
	3/8"	40	rubber	30 l/min	F 3/8" G	F 3/8" G	I562/36
	3/8"	50	rubber	28 l/min	F 3/8" G	F 3/8" G	I562/37



Fixed and swivelling bracket see page 40-41

Industrial Series

in painted steel
Air / water
20 bar

Swivel: Brass
Seals: Viton
Hose: Blue hygienic covering



S. 560



S. 430



S. 300

	Dimension	Length (m)	Hose	Flow	Inlet	Outlet	Item
Series 300	Without hose	-	-	800 l/min	F 3/8" G	F 3/8" G	I300/10
	3/8"	12	hygienic	690 l/min	F 3/8" G	M 3/8" G	I301/11
Series 350	Without hose	-	-	800 l/min	F 3/8" G	F 3/8" G	I350/10
	3/8"	12	hygienic	690 l/min	F 3/8" G	M 3/8" G	I351/11
	3/8"	17	hygienic	660 l/min	F 3/8" G	M 3/8" G	I351/12
Series 430	Without hose	-	-	800 l/min	F 1/2" G	F 1/2" G	I430/10
	1/2"	10	hygienic	780 l/min	F 1/2" G	M 1/2" G	I431/11
	1/2"	15	hygienic	760 l/min	F 1/2" G	M 1/2" G	I431/12
Series 530	Without hose	-	-	800 l/min	F 1/2" G	F 1/2" G	I530/10
	1/2"	25	hygienic	750 l/min	F 1/2" G	M 1/2" G	I531/11
	1/2"	20	hygienic	740 l/min	F 1/2" G	M 1/2" G	I531/12
Series 540	Without hose	-	-	3000 l/min	F 1" G	F 1" G	I540/10
	3/4"	15	hygienic	2800 l/min	F 1" G	M 3/4" G	I541/11
	3/4"	20	hygienic	2750 l/min	F 1" G	M 3/4" G	I541/12
	1"	15	hygienic	3000 l/min	F 1" G	M 1" G	I541/13
	Without hose	-	-	800 l/min	F 1/2" G	F 1/2" G	I540/15
	1/2"	30	hygienic	720 l/min	F 1/2" G	M 1/2" G	I541/16
Series 560	Without hose	-	-	3000 l/min	F 1" G	F 1" G	I560/10
	3/4"	30	hygienic	2700 l/min	F 1" G	M 3/4" G	I561/11
	3/4"	35	hygienic	2650 l/min	F 1" G	M 3/4" G	I561/12
	3/4"	40	hygienic	2600 l/min	F 1" G	M 3/4" G	I561/13
	1"	20	hygienic	2950 l/min	F 1" G	M 1" G	I561/14
	1"	30	hygienic	2900 l/min	F 1" G	M 1" G	I561/15
	Without hose	-	-	800 l/min	F 1/2" G	F 1/2" G	I560/16
	1/2"	40	hygienic	700 l/min	F 1/2" G	M 1/2" G	I561/17
	1/2"	50	hygienic	680 l/min	F 1/2" G	M 1/2" G	I561/18
	1/2"	60	hygienic	660 l/min	F 1/2" G	M 1/2" G	I561/19



Fixed and swivelling bracket see page 40-41

Industrial Series

in stainless steel AISI 304

Air / water
20 bar

Swivel: Brass
Seals: Viton
Hose: Blue hygienic covering

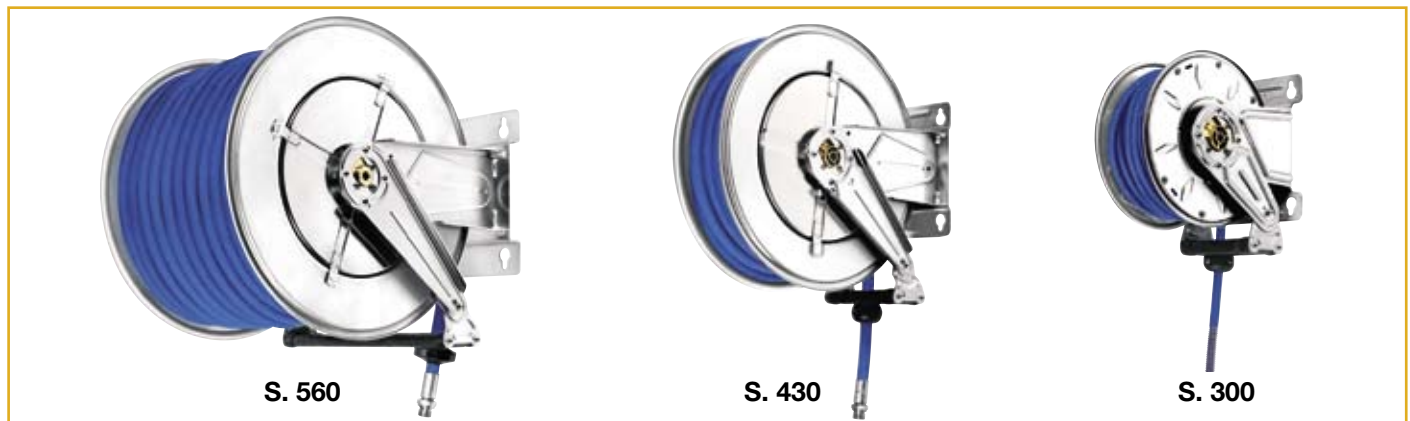

	Dimension	Length (m)	Hose	Flow	Inlet	Outlet	Item
Series 300	Without hose	-	-	800 l/min	F 3/8" G	F 3/8" G	I302/10
	3/8"	12	hygienic	690 l/min	F 3/8" G	M 3/8" G	I303/11
Series 350	Without hose	-	-	800 l/min	F 3/8" G	F 3/8" G	I352/10
	3/8"	12	hygienic	690 l/min	F 3/8" G	M 3/8" G	I353/11
	3/8"	17	hygienic	660 l/min	F 3/8" G	M 3/8" G	I353/12
Series 430	Without hose	-	-	800 l/min	F 1/2" G	F 1/2" G	I432/10
	1/2"	10	hygienic	780 l/min	F 1/2" G	M 1/2" G	I433/11
	1/2"	15	hygienic	760 l/min	F 1/2" G	M 1/2" G	I433/12
Series 530	Without hose	-	-	800 l/min	F 1/2" G	F 1/2" G	I532/10
	1/2"	25	hygienic	750 l/min	F 1/2" G	M 1/2" G	I533/11
	1/2"	20	hygienic	740 l/min	F 1/2" G	M 1/2" G	I533/12
Series 540	Without hose	-	-	3000 l/min	F 1" G	F 1" G	I542/10
	3/4"	15	hygienic	2800 l/min	F 1" G	M 3/4" G	I543/11
	3/4"	20	hygienic	2750 l/min	F 1" G	M 3/4" G	I543/12
	1"	15	hygienic	3000 l/min	F 1" G	M 1" G	I543/13
	Without hose	-	-	800 l/min	F 1/2" G	F 1/2" G	I542/15
	1/2"	30	hygienic	720 l/min	F 1/2" G	M 1/2" G	I543/16
Series 560	Without hose	-	-	3000 l/min	F 1" G	F 1" G	I562/10
	3/4"	30	hygienic	2700 l/min	F 1" G	M 3/4" G	I563/11
	3/4"	35	hygienic	2650 l/min	F 1" G	M 3/4" G	I563/12
	3/4"	40	hygienic	2600 l/min	F 1" G	M 3/4" G	I563/13
	1"	20	hygienic	2950 l/min	F 1" G	M 1" G	I563/14
	1"	30	hygienic	2900 l/min	F 1" G	M 1" G	I563/15
	Without hose	-	-	800 l/min	F 1/2" G	F 1/2" G	I562/16
	1/2"	40	hygienic	700 l/min	F 1/2" G	M 1/2" G	I563/17
	1/2"	50	hygienic	680 l/min	F 1/2" G	M 1/2" G	I563/18
	1/2"	60	hygienic	660 l/min	F 1/2" G	M 1/2" G	I563/19



Fixed and swivelling bracket see page 40-41

Industrial Series

in painted steel
Water - Hot water max. 130°C
200 bar

Swivel: St. steel AISI 304
Seals: Viton
Hose: Blue hygienic covering

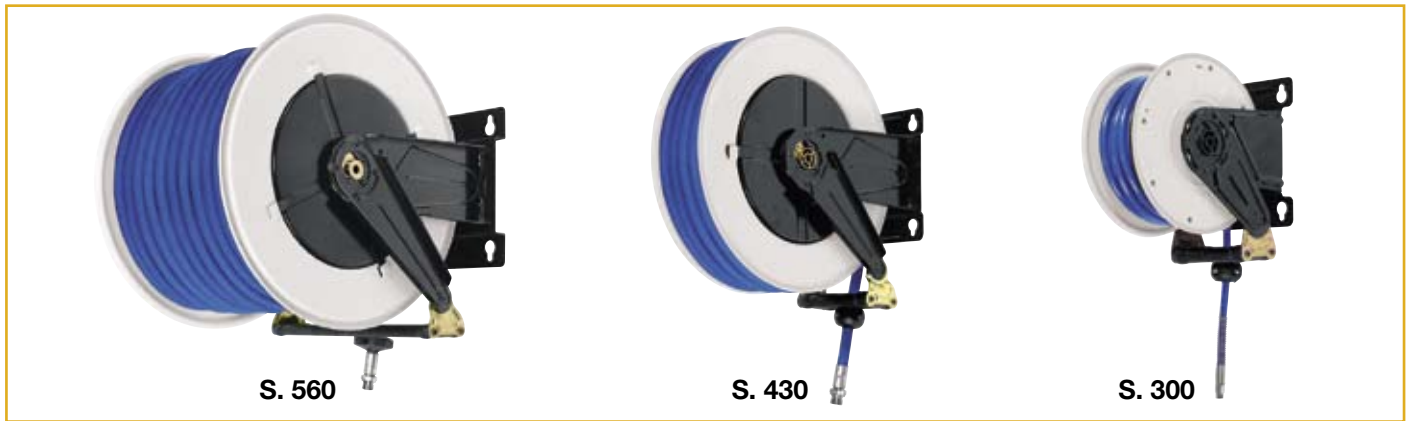

	Dimension	Length (m)	Hose	Flow	Inlet	Outlet	Item
Series 300	Without hose	-	-	30 l/min	F 3/8" G	F 3/8" G	I300/30
	5/16"	12	hygienic	25 l/min	F 3/8" G	F 3/8" G	I301/31
Series 350	Without hose	-	-	30 l/min	F 3/8" G	F 3/8" G	I350/30
	5/16"	12	hygienic	25 l/min	F 3/8" G	F 3/8" G	I351/31
	5/16"	17	hygienic	24 l/min	F 3/8" G	F 3/8" G	I351/32
Series 430	Without hose	-	-	30 l/min	F 3/8" G	F 1/2" G	I430/30
	3/8"	12	hygienic	27 l/min	F 3/8" G	F 3/8" G	I431/31
	3/8"	18	hygienic	25 l/min	F 3/8" G	F 3/8" G	I431/32
Series 530	Without hose	-	-	30 l/min	F 3/8" G	F 1/2" G	I530/30
	3/8"	25	hygienic	25 l/min	F 3/8" G	F 3/8" G	I531/31
	3/8"	20	hygienic	24 l/min	F 3/8" G	F 3/8" G	I531/32
Series 540	Without hose	-	-	30 l/min	F 3/8" G	F 1/2" G	I540/30
	3/8"	30	hygienic	22 l/min	F 3/8" G	F 3/8" G	I541/31
Series 560	Without hose	-	-	30 l/min	F 3/8" G	F 1/2" G	I560/30
	3/8"	40	hygienic	20 l/min	F 3/8" G	F 3/8" G	I561/31
	3/8"	50	hygienic	18 l/min	F 3/8" G	F 3/8" G	I561/32



Fixed and swivelling bracket see page 40-41

Industrial Series

in stainless steel AISI 304
Water - Hot water max. 130°C
200 bar

Swivel: St. steel AISI 304
Seals: Viton
Hose: Blue hygienic covering



	Dimension	Length (m)	Hose	Flow	Inlet	Outlet	Item
Series 300	Without hose	-	-	30 l/min	F 3/8" G	F 3/8" G	I302/30
	5/16"	12	hygienic	25 l/min	F 3/8" G	F 3/8" G	I303/31
Series 350	Without hose	-	-	30 l/min	F 3/8" G	F 3/8" G	I352/30
	5/16"	12	hygienic	25 l/min	F 3/8" G	F 3/8" G	I353/31
	5/16"	17	hygienic	24 l/min	F 3/8" G	F 3/8" G	I353/32
Series 430	Without hose	-	-	30 l/min	F 3/8" G	F 1/2" G	I432/30
	3/8"	12	hygienic	27 l/min	F 3/8" G	F 3/8" G	I433/31
	3/8"	18	hygienic	25 l/min	F 3/8" G	F 3/8" G	I433/32
Series 530	Without hose	-	-	30 l/min	F 3/8" G	F 1/2" G	I532/30
	3/8"	25	hygienic	25 l/min	F 3/8" G	F 3/8" G	I533/31
	3/8"	20	hygienic	24 l/min	F 3/8" G	F 3/8" G	I533/32
Series 540	Without hose	-	-	30 l/min	F 3/8" G	F 1/2" G	I544/30
	3/8"	30	hygienic	22 l/min	F 3/8" G	F 3/8" G	I543/32
Series 560	Without hose	-	-	30 l/min	F 3/8" G	F 1/2" G	I564/31
	3/8"	40	hygienic	20 l/min	F 3/8" G	F 3/8" G	I563/32
	3/8"	50	hygienic	18 l/min	F 3/8" G	F 3/8" G	I563/33



Fixed and swivelling bracket see page 40-41

Industrial Series

in painted steel
Water - Hot water max. 130°C
400 bar

Swivel: St. steel AISI 304
Seals: Teflon
Hose: Blue hygienic covering

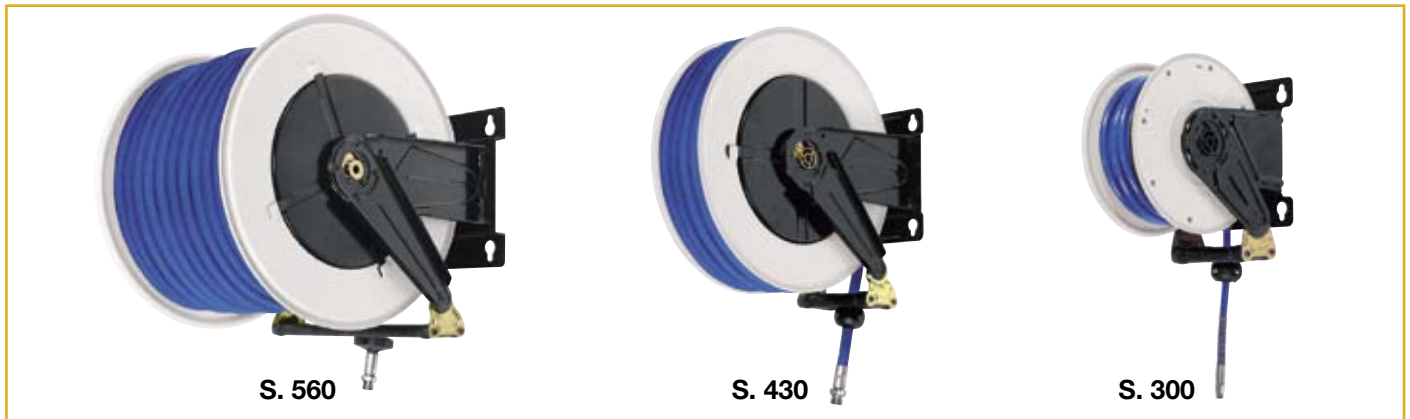

	Dimension	Length (m)	Hose	Flow	Inlet	Outlet	Item
Series 300	Without hose	-	-	40 l/min	F 3/8" G	F 3/8" G	I300/35
	5/16"	12	hygienic	38 l/min	F 3/8" G	F 3/8" G	I301/36
Series 350	Without hose	-	-	40 l/min	F 3/8" G	F 3/8" G	I350/35
	5/16"	12	hygienic	38 l/min	F 3/8" G	F 3/8" G	I351/36
	5/16"	17	hygienic	35 l/min	F 3/8" G	F 3/8" G	I351/37
Series 430	Without hose	-	-	40 l/min	F 3/8" G	F 1/2" G	I430/35
	3/8"	12	hygienic	40 l/min	F 3/8" G	F 3/8" G	I431/36
	3/8"	18	hygienic	38 l/min	F 3/8" G	F 3/8" G	I431/37
Series 530	Without hose	-	-	40 l/min	F 3/8" G	F 1/2" G	I530/35
	3/8"	25	hygienic	38 l/min	F 3/8" G	F 3/8" G	I531/36
	3/8"	20	hygienic	35 l/min	F 3/8" G	F 3/8" G	I531/37
Series 540	Without hose	-	-	40 l/min	F 3/8" G	F 1/2" G	I540/35
	3/8"	30	hygienic	33 l/min	F 3/8" G	F 3/8" G	I541/36
Series 560	Without hose	-	-	40 l/min	F 3/8" G	F 1/2" G	I560/35
	3/8"	40	hygienic	30 l/min	F 3/8" G	F 3/8" G	I561/36
	3/8"	50	hygienic	28 l/min	F 3/8" G	F 3/8" G	I561/37



Fixed and swivelling bracket see page 40-41

Industrial Series

in stainless steel AISI 304
Water - Hot water max. 130°C
400 bar

Swivel: St. steel AISI 304
Seals: Teflon
Hose: Blue hygienic covering



	Dimension	Length (m)	Hose	Flow	Inlet	Outlet	Item
Series 300	Without hose	-	-	40 l/min	F 3/8" G	F 3/8" G	I302/35
	5/16"	12	hygienic	38 l/min	F 3/8" G	F 3/8" G	I303/36
Series 350	Without hose	-	-	40 l/min	F 3/8" G	F 3/8" G	I352/35
	5/16"	12	hygienic	38 l/min	F 3/8" G	F 3/8" G	I353/36
	5/16"	17	hygienic	35 l/min	F 3/8" G	F 3/8" G	I353/37
Series 430	Without hose	-	-	40 l/min	F 3/8" G	F 1/2" G	I434/35
	3/8"	12	hygienic	40 l/min	F 3/8" G	F 3/8" G	I433/36
	3/8"	18	hygienic	38 l/min	F 3/8" G	F 3/8" G	I433/37
Series 530	Without hose	-	-	40 l/min	F 3/8" G	F 1/2" G	I534/35
	3/8"	25	hygienic	38 l/min	F 3/8" G	F 3/8" G	I533/36
	3/8"	20	hygienic	35 l/min	F 3/8" G	F 3/8" G	I533/37
Series 540	Without hose	-	-	40 l/min	F 3/8" G	F 1/2" G	I544/35
	3/8"	30	hygienic	33 l/min	F 3/8" G	F 3/8" G	I543/36
Series 560	Without hose	-	-	40 l/min	F 3/8" G	F 1/2" G	I564/35
	3/8"	40	hygienic	30 l/min	F 3/8" G	F 3/8" G	I563/36
	3/8"	50	hygienic	28 l/min	F 3/8" G	F 3/8" G	I563/37



Fixed and swivelling bracket see page 40-41

Industrial Series

in painted steel
Oil - Antifreeze and allied products
150 bar

Swivel: Steel
Seals: Polyurethane
Hose: Black synthetic rubber



	Dimension	Length (m)	Hose	Flow	Inlet	Outlet	Item
Series 300	Without hose	-	-	18 l/min	F 1/2" G	F 3/8" - F 1/2" G	I300/40
	1/2"	8	rubber	13 l/min	F 1/2" G	M 1/2" G	I300/41
	3/8"	12	rubber	11 l/min	F 1/2" G	M 1/2" G	I300/42
Series 350	Without hose	-	-	18 l/min	F 1/2" G	F 3/8" - F 1/2" G	I350/40
	1/2"	10	rubber	12 l/min	F 1/2" G	M 1/2" G	I350/41
	3/8"	17	rubber	9 l/min	F 1/2" G	M 1/2" G	I350/42
	3/8"	12	rubber	11 l/min	F 1/2" G	M 1/2" G	I350/43
Series 430	Without hose	-	-	20 l/min	F 1/2" G	F 1/2" G	I430/40
	1/2"	10	rubber	14 l/min	F 1/2" G	M 1/2" G	I430/41
	1/2"	15	rubber	12 l/min	F 1/2" G	M 1/2" G	I430/42
Series 530	Without hose	-	-	20 l/min	F 1/2" G	F 1/2" G	I530/40
	1/2"	20	rubber	10 l/min	F 1/2" G	M 1/2" G	I530/41
	1/2"	25	rubber	9 l/min	F 1/2" G	M 1/2" G	I530/42
Series 540	Without hose	-	-	40 l/min	F 1" G	F 1" G	I540/40
	1"	15	rubber	35 l/min	F 1" G	M 1" G	I540/41
	3/4"	15	rubber	30 l/min	F 1" G	M 3/4" G	I540/42
	3/4"	20	rubber	26 l/min	F 1" G	M 3/4" G	I540/43
	Without hose	-	-	20 l/min	F 1/2" G	F 1/2" G	I540/45
	1/2"	30	rubber	8 l/min	F 1/2" G	M 1/2" G	I540/46
Series 560	Without hose	-	-	40 l/min	F 1" G	F 1" G	I560/40
	3/4"	30	rubber	22 l/min	F 1" G	M 3/4" G	I560/41
	3/4"	35	rubber	20 l/min	F 1" G	M 3/4" G	I560/42
	3/4"	40	rubber	18 l/min	F 1" G	M 3/4" G	I560/43
	1"	20	rubber	32 l/min	F 1" G	M 1" G	I560/44
	1"	30	rubber	30 l/min	F 1" G	M 1" G	I560/45
	Without hose	-	-	20 l/min	F 1/2" G	F 1/2" G	I560/46
	1/2"	40	rubber	7 l/min	F 1/2" G	M 1/2" G	I560/47
	1/2"	50	rubber	6 l/min	F 1/2" G	M 1/2" G	I560/48
	1/2"	60	rubber	5 l/min	F 1/2" G	M 1/2" G	I560/49



Fixed and swivelling bracket see page 40-41

Industrial Series

in stainless steel AISI 304

Oil - Antifreeze and allied products

150 bar

Swivel:

St. steel AISI 304

Seals:

Viton

Hose:

Black synthetic rubber



S. 560



S. 530



S. 300

	Dimension	Length (m)	Hose	Flow	Inlet	Outlet	Item
Series 300	Without hose	-	-	18 l/min	F 1/2" G	F 3/8" - F 1/2" G	I302/40
	1/2"	8	rubber	13 l/min	F 1/2" G	M 1/2" G	I302/41
	3/8"	12	rubber	11 l/min	F 1/2" G	M 1/2" G	I302/42
Series 350	Without hose	-	-	18 l/min	F 1/2" G	F 3/8" - F 1/2" G	I352/40
	1/2"	10	rubber	12 l/min	F 1/2" G	M 1/2" G	I352/41
	3/8"	17	rubber	9 l/min	F 1/2" G	M 1/2" G	I352/42
	3/8"	12	rubber	11 l/min	F 1/2" G	M 1/2" G	I352/43
Series 430	Without hose	-	-	20 l/min	F 1/2" G	F 1/2" G	I434/20
	1/2"	10	rubber	14 l/min	F 1/2" G	M 1/2" G	I432/41
	1/2"	15	rubber	12 l/min	F 1/2" G	M 1/2" G	I432/42
Series 530	Without hose	-	-	20 l/min	F 1/2" G	F 1/2" G	I534/20
	1/2"	20	rubber	10 l/min	F 1/2" G	M 1/2" G	I532/41
	1/2"	25	rubber	9 l/min	F 1/2" G	M 1/2" G	I532/42
Series 540	Without hose	-	-	40 l/min	F 1" G	F 1" G	I544/20
	1"	15	rubber	35 l/min	F 1" G	M 1" G	I542/41
	3/4"	15	rubber	30 l/min	F 1" G	M 3/4" G	I542/42
	3/4"	20	rubber	26 l/min	F 1" G	M 3/4" G	I542/43
	Without hose	-	-	20 l/min	F 1/2" G	F 1/2" G	I544/25
Series 560	1/2"	30	rubber	8 l/min	F 1/2" G	M 1/2" G	I542/46
	Without hose	-	-	40 l/min	F 1" G	F 1" G	I564/20
	3/4"	30	rubber	22 l/min	F 1" G	M 3/4" G	I562/41
	3/4"	35	rubber	20 l/min	F 1" G	M 3/4" G	I562/42
	3/4"	40	rubber	18 l/min	F 1" G	M 3/4" G	I562/43
	1"	20	rubber	32 l/min	F 1" G	M 1" G	I562/44
	1"	30	rubber	30 l/min	F 1" G	M 1" G	I562/45
	Without hose	-	-	20 l/min	F 1/2" G	F 1/2" G	I564/26
	1/2"	40	rubber	7 l/min	F 1/2" G	M 1/2" G	I562/47
1/2"	50	rubber	6 l/min	F 1/2" G	M 1/2" G	I562/48	
1/2"	60	rubber	5 l/min	F 1/2" G	M 1/2" G	I562/49	



Fixed and swivelling bracket see page 40-41

Industrial Series

in painted steel
Grease
600 bar

Swivel: Steel
Seals: Polyurethane
Hose: Black synthetic rubber



	Dimension	Length (m)	Hose	Flow	Inlet	Outlet	Item
Series 300	Without hose	-	-	1200 g/min	F 3/8" G	F 3/8" G	I300/50
	1/4"	12	rubber	650 g/min	F 3/8" G	M 1/4" G	I300/51
Series 350	Without hose	-	-	1200 g/min	F 3/8" G	F 3/8" G	I350/50
	1/4"	12	rubber	650 g/min	F 3/8" G	M 1/4" G	I350/51
	1/4"	16	rubber	550 g/min	F 3/8" G	M 1/4" G	I350/52
Series 430	Without hose	-	-	1200 g/min	F 3/8" G	F 1/2" G	I430/50
	1/4"	12	rubber	650 g/min	F 3/8" G	M 1/4" G	I430/51
	1/4"	18	rubber	550 g/min	F 3/8" G	M 1/4" G	I430/52
	3/8"	10	rubber	800 g/min	F 3/8" G	M 1/4" G	I430/55
	3/8"	15	rubber	750 g/min	F 3/8" G	M 1/4" G	I430/56
Series 530	Without hose	-	-	1200 g/min	F 3/8" G	F 1/2" G	I530/50
	3/8"	20	rubber	600 g/min	F 3/8" G	M 1/4" G	I530/51
	3/8"	25	rubber	500 g/min	F 3/8" G	M 1/4" G	I530/52
Series 540	Without hose	-	-	1200 g/min	F 3/8" G	F 1/2" G	I540/50
	3/8"	30	rubber	450 g/min	F 3/8" G	M 1/4" G	I540/51



Fixed and swivelling bracket see page 40-41

Industrial Series

in stainless steel AISI 304

Grease
600 bar

Swivel: Steel
Seals: Polyurethane
Hose: Black synthetic rubber



S. 540



S. 350



S. 300

	Dimension	Length (m)	Hose	Flow	Inlet	Outlet	Item
Series 300	Without hose	-	-	1200 g/min	F 3/8" G	F 3/8" G	I302/50
	1/4"	12	rubber	650 g/min	F 3/8" G	M 1/4" G	I302/51
Series 350	Without hose	-	-	1200 g/min	F 3/8" G	F 3/8" G	I352/50
	1/4"	12	rubber	650 g/min	F 3/8" G	M 1/4" G	I352/51
	1/4"	16	rubber	550 g/min	F 3/8" G	M 1/4" G	I352/52
Series 430	Without hose	-	-	1200 g/min	F 3/8" G	F 1/2" G	I432/50
	1/4"	12	rubber	650 g/min	F 3/8" G	M 1/4" G	I432/51
	1/4"	18	rubber	550 g/min	F 3/8" G	M 1/4" G	I432/52
	3/8"	10	rubber	800 g/min	F 3/8" G	M 1/4" G	I432/55
	3/8"	15	rubber	750 g/min	F 3/8" G	M 1/4" G	I432/56
Series 530	Without hose	-	-	1200 g/min	F 3/8" G	F 1/2" G	I532/50
	3/8"	20	rubber	600 g/min	F 3/8" G	M 1/4" G	I532/51
	3/8"	25	rubber	500 g/min	F 3/8" G	M 1/4" G	I532/52
Series 540	Without hose	-	-	1200 g/min	F 3/8" G	F 1/2" G	I542/50
	3/8"	30	rubber	450 g/min	F 3/8" G	M 1/4" G	I542/51



Fixed and swivelling bracket see page 40-41

Industrial Series

in painted steel
Diesel fuel and kerosene
10 bar

Swivel: Brass
Seals: Viton
Hose: Antistatic black synthetic rubber

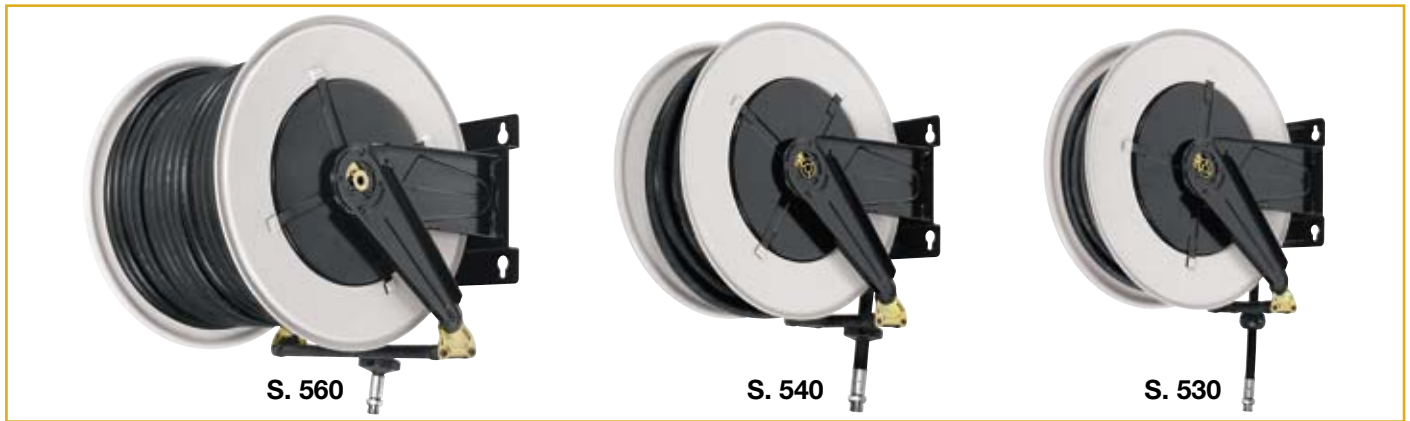

	Dimension	Length (m)	Hose	Flow	Inlet	Outlet	Item
Series 530	Without hose	-	-	50 l/min	F 1/2" G	F 1/2" G	I530/10
	13/20mm	20	rubber	45 l/min	F 1/2" G	M 1/2" G	I530/61
	13/20mm	25	rubber	43 l/min	F 1/2" G	M 1/2" G	I530/62
	Without hose	-	-	100 l/min	F 1" G	F 1" G	I530/60
	19/27mm	12	rubber	87 l/min	F 1" G	M 3/4" G	I530/63
	25/35mm	8	rubber	93 l/min	F 1" G	M 1" G	I530/64
Series 540	Without hose	-	-	100 l/min	F 1" G	F 1" G	I540/10
	19/27mm	15	rubber	85 l/min	F 1" G	M 3/4" G	I540/61
	19/27mm	20	rubber	83 l/min	F 1" G	M 3/4" G	I540/62
	25/35mm	15	rubber	90 l/min	F 1" G	M 1" G	I540/63
	Without hose	-	-	100 l/min	F 1" G	F 1" G	I560/10
Series 560	Without hose	-	-	100 l/min	F 1" G	F 1" G	I560/10
	19/27mm	30	rubber	80 l/min	F 1" G	M 3/4" G	I560/61
	19/27mm	35	rubber	78 l/min	F 1" G	M 3/4" G	I560/62
	19/27mm	40	rubber	76 l/min	F 1" G	M 3/4" G	I560/63
	25/35mm	20	rubber	87 l/min	F 1" G	M 1" G	I560/64
	25/35mm	30	rubber	85 l/min	F 1" G	M 1" G	I560/65



Fixed and swivelling bracket see page 40-41

Industrial Series

in stainless steel AISI 304
Diesel fuel and kerosene
10 bar

Swivel: Brass
Seals: Viton
Hose: Antistatic black synthetic rubber

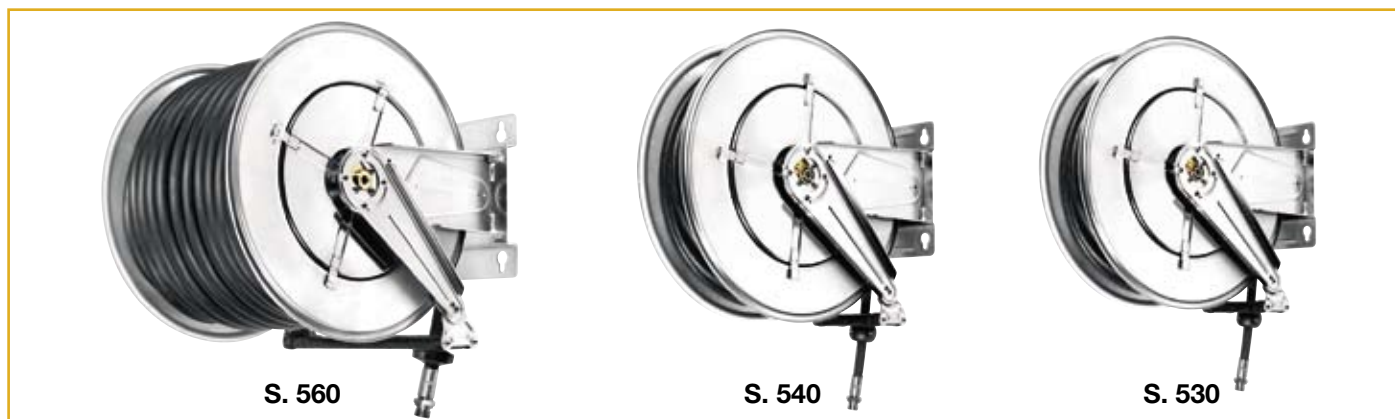

	Dimension	Length (m)	Hose	Flow	Inlet	Outlet	Item
Series 530	Without hose	-	-	50 l/min	F 1/2" G	F 1/2" G	I532/10
	13/20mm	20	rubber	45 l/min	F 1/2" G	M 1/2" G	I532/61
	13/20mm	25	rubber	43 l/min	F 1/2" G	M 1/2" G	I532/62
Series 540	Without hose	-	-	100 l/min	F 1" G	F 1" G	I542/10
	19/27mm	15	rubber	85 l/min	F 1" G	M 3/4" G	I542/61
	19/27mm	20	rubber	83 l/min	F 1" G	M 3/4" G	I542/62
	25/35mm	15	rubber	90 l/min	F 1" G	M 1" G	I542/63
Series 560	Without hose	-	-	100 l/min	F 1" G	F 1" G	I562/10
	19/27mm	30	rubber	80 l/min	F 1" G	M 3/4" G	I562/61
	19/27mm	35	rubber	78 l/min	F 1" G	M 3/4" G	I562/62
	19/27mm	40	rubber	76 l/min	F 1" G	M 3/4" G	I562/63
	25/35mm	20	rubber	87 l/min	F 1" G	M 1" G	I562/64
	25/35mm	30	rubber	85 l/min	F 1" G	M 1" G	I562/65



Fixed and swivelling bracket see page 40-41

Industrial Series

in painted steel
Oxygen - Acetylene
20 bar

Swivel: Brass
Seals: Viton
Hose: SBR/EPDM



S. 540



S. 530



S. 430

	Dimension	Length (m)	Hose	Flow	Inlet	Outlet	Item
Series 430	Without hose	-	-	800 l/min	M 3/8" G	M 3/8" G	I430/70
	2x1/4"	13	SBR/EPDM	250 l/min	F 3/8" G	F 3/8" G	I430/71
	2x5/16"	12	SBR/EPDM	360 l/min	F 3/8" G	F 3/8" G	I430/72
Series 530	Without hose	-	-	800 l/min	M 3/8" G	M 3/8" G	I530/70
	2x1/4"	17	SBR/EPDM	220 l/min	F 3/8" G	F 3/8" G	I530/71
	2x1/4"	20	SBR/EPDM	200 l/min	F 3/8" G	F 3/8" G	I530/72
	2x5/16"	15	SBR/EPDM	300 l/min	F 3/8" G	F 3/8" G	I530/73
	2x5/16"	20	SBR/EPDM	290 l/min	F 3/8" G	F 3/8" G	I530/74
	2x3/8"	15	SBR/EPDM	660 l/min	F 3/8" G	F 3/8" G	I530/75
Series 540	Without hose	-	-	800 l/min	M 3/8" G	M 3/8" G	I540/70
	2x1/4"	25	SBR/EPDM	180 l/min	F 3/8" G	F 3/8" G	I540/71
	2x1/4"	30	SBR/EPDM	160 l/min	F 3/8" G	F 3/8" G	I540/72
	2x1/4"	35	SBR/EPDM	140 l/min	F 3/8" G	F 3/8" G	I540/73
	2x5/16"	25	SBR/EPDM	270 l/min	F 3/8" G	F 3/8" G	I540/74
	2x5/16"	30	SBR/EPDM	250 l/min	F 3/8" G	F 3/8" G	I540/75
	2x5/16"	35	SBR/EPDM	230 l/min	F 3/8" G	F 3/8" G	I540/76
	2x3/8"	20	SBR/EPDM	640 l/min	F 3/8" G	F 3/8" G	I540/77
	2x3/8"	25	SBR/EPDM	600 l/min	F 3/8" G	F 3/8" G	I540/78
2x3/8"	27	SBR/EPDM	570 l/min	F 3/8" G	F 3/8" G	I540/79	



Fixed and swivelling bracket see page 40-41

Industrial Series

in stainless steel AISI 304
Oxygen - Acetylene
20 bar

Swivel: Brass
Seals: Viton
Hose: SBR/EPDM



S. 540



S. 530



S. 430

	Dimension	Length (m)	Hose	Flow	Inlet	Outlet	Item
Series 430	Without hose	-	-	800 l/min	M 3/8" G	M 3/8" G	1432/70
	2x1/4"	13	SBR/EPDM	250 l/min	F 3/8" G	F 3/8" G	1432/71
	2x5/16"	12	SBR/EPDM	360 l/min	F 3/8" G	F 3/8" G	1432/72
Series 530	Without hose	-	-	800 l/min	M 3/8" G	M 3/8" G	1532/70
	2x1/4"	17	SBR/EPDM	220 l/min	F 3/8" G	F 3/8" G	1532/71
	2x1/4"	20	SBR/EPDM	200 l/min	F 3/8" G	F 3/8" G	1532/72
	2x5/16"	15	SBR/EPDM	300 l/min	F 3/8" G	F 3/8" G	1532/73
	2x5/16"	20	SBR/EPDM	290 l/min	F 3/8" G	F 3/8" G	1532/74
	2x3/8"	15	SBR/EPDM	660 l/min	F 3/8" G	F 3/8" G	1532/75
Series 540	Without hose	-	-	800 l/min	M 3/8" G	M 3/8" G	1542/70
	2x1/4"	25	SBR/EPDM	180 l/min	F 3/8" G	F 3/8" G	1542/71
	2x1/4"	30	SBR/EPDM	160 l/min	F 3/8" G	F 3/8" G	1542/72
	2x1/4"	35	SBR/EPDM	140 l/min	F 3/8" G	F 3/8" G	1542/73
	2x5/16"	25	SBR/EPDM	270 l/min	F 3/8" G	F 3/8" G	1542/74
	2x5/16"	30	SBR/EPDM	250 l/min	F 3/8" G	F 3/8" G	1542/75
	2x5/16"	35	SBR/EPDM	230 l/min	F 3/8" G	F 3/8" G	1542/76
	2x3/8"	20	SBR/EPDM	640 l/min	F 3/8" G	F 3/8" G	1542/77
	2x3/8"	25	SBR/EPDM	600 l/min	F 3/8" G	F 3/8" G	1542/78
	2x3/8"	27	SBR/EPDM	570 l/min	F 3/8" G	F 3/8" G	1542/79



Fixed and swivelling bracket see page 40-41

Industrial Series

in painted steel
LPG - methane
20 bar

Swivel:
Seals:
Hose:

Brass
Viton
NBR/PVC



S. 540



S. 430



S. 300

	Dimension	Length (m)	Hose	Flow	Inlet	Outlet	Item
Series 300	Without hose	-	-	800 l/min	M 3/8" G Left	M 3/8" G Left	I300/80
	8/15mm	8	NBR/PVC	400 l/min	F 3/8" G Left	F 3/8" G Left	I300/81
	10/17mm	10	NBR/PVC	720 l/min	F 3/8" G Left	F 3/8" G Left	I300/82
Series 350	Without hose	-	-	800 l/min	M 3/8" G Left	M 3/8" G Left	I350/80
	8/15mm	15	NBR/PVC	350 l/min	F 3/8" G Left	F 3/8" G Left	I350/81
	10/17mm	15	NBR/PVC	700 l/min	F 3/8" G Left	F 3/8" G Left	I350/82
Series 430	Without hose	-	-	800 l/min	M 3/8" G Left	M 3/8" G Left	I430/80
	8/15mm	15	NBR/PVC	350 l/min	F 3/8" G Left	F 3/8" G Left	I430/81
	8/15mm	20	NBR/PVC	320 l/min	F 3/8" G Left	F 3/8" G Left	I430/82
	10/17mm	12	NBR/PVC	700 l/min	F 3/8" G Left	F 3/8" G Left	I430/83
	10/17mm	18	NBR/PVC	680 l/min	F 3/8" G Left	F 3/8" G Left	I430/84
Series 530	Without hose	-	-	800 l/min	M 3/8" G Left	M 3/8" G Left	I530/80
	8/15mm	24	NBR/PVC	300 l/min	F 3/8" G Left	F 3/8" G Left	I530/81
	8/15mm	28	NBR/PVC	270 l/min	F 3/8" G Left	F 3/8" G Left	I530/82
	10/17mm	22	NBR/PVC	660 l/min	F 3/8" G Left	F 3/8" G Left	I530/83
	10/17mm	27	NBR/PVC	630 l/min	F 3/8" G Left	F 3/8" G Left	I530/84
Series 540	Without hose	-	-	800 l/min	M 3/8" G Left	M 3/8" G Left	I540/80
	8/15mm	30	NBR/PVC	260 l/min	F 3/8" G Left	F 3/8" G Left	I540/81
	10/17mm	30	NBR/PVC	620 l/min	F 3/8" G Left	F 3/8" G Left	I540/82



Fixed and swivelling bracket see page 40-41

Industrial Series

enclosed in painted steel / technopolimer
Air / cold water, oil and grease

Swivel: Brass
Seals: Viton
Hose: SBR/EPDM



S. 440.



S. 260

Painted steel
Air / water
20 bar

Swivel: Brass
Seals: Viton
Hose: Black synthetic rubber

	Dimension	Length (m)	Hose	Flow	Inlet	Outlet	Item
Series 440	Without hose	-	-	800 l/min	F 1/2" G	F 1/2" G	I440/10
	1/2"	15	rubber	760 l/min	F 1/2" G	M 1/2" G	I440/11
	3/8"	12	rubber	690 l/min	F 1/2" G	M 3/8" G	I440/12
	3/8"	18	rubber	640 l/min	F 1/2" G	M 3/8" G	I440/13
	1/2"	10	rubber	780 l/min	F 1/2" G	M 1/2" G	I440/14

Painted steel
Oil
150 bar

Swivel: Steel
Seals: Polyurethane
Hose: Black rubber

	Dimension	Length (m)	Hose	Flow	Inlet	Outlet	Item
Series 440	Without hose	-	-	20 l/min	F 1/2" G	F 1/2" G	I440/40
	1/2"	10	rubber	14 l/min	F 1/2" G	M 1/2" G	I440/41
	1/2"	15	rubber	12 l/min	F 1/2" G	M 1/2" G	I440/42

Painted steel
Grease
600 bar

Swivel: Steel
Seals: Polyurethane
Hose: Black rubber

	Dimension	Length (m)	Hose	Flow	Inlet	Outlet	Item
Series 440	Without hose	-	-	1200 g/min	F 3/8" G	F 1/2" G	I440/50
	1/4"	12	rubber	650 g/min	F 3/8" G	M 1/4" G	I440/51
	1/4"	18	rubber	550 g/min	F 3/8" G	M 1/4" G	I440/52
	3/8"	10	rubber	800 g/min	F 3/8" G	M 1/4" G	I440/55
	3/8"	15	rubber	750 g/min	F 3/8" G	M 1/4" G	I440/56

Enclosed in shock resistant technopolimer
Air / cold water
20 bar

Swivel: Brass
Seals: Viton
Hose: Polyurethane

	Dimension	Length (m)	Hose	Flow	Inlet	Outlet	Item
Series 260	8/12mm	11	PU	350 l/min	M 1/4" G	M 1/4" G	I261/11
	6/10mm	11	PU	280 l/min	M 1/4" G	M 1/4" G	I261/12



Fixed and swivelling bracket see page 40-41

Industrial Series

motor operated
Air / water
20 bar

Swivel: Brass
Seals: Viton
Hose: Black synthetic rubber

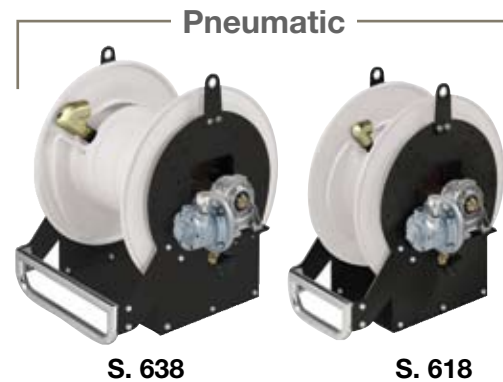
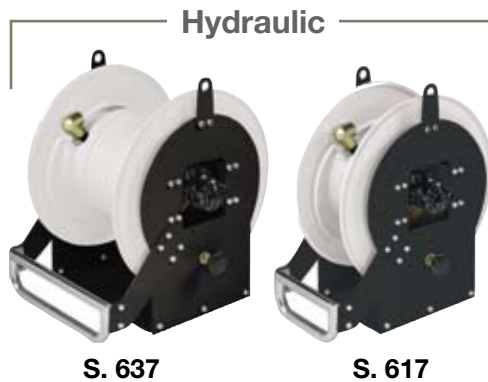

	Dimension	Length (m)	Hose	Flow	Inlet	Outlet	Item
Serie 617 Hydraulic motor operated	Without hose	-	-	3500 l/min	F 1" G	F 1" G	1617/100
	1/2"	30	rubber	720 l/min	F 1" G	M 1/2" G	1617/101
	1/2"	40	rubber	700 l/min	F 1" G	M 1/2" G	1617/102
	1/2"	50	rubber	680 l/min	F 1" G	M 1/2" G	1617/103
	3/4"	15	rubber	2800 l/min	F 1" G	M 3/4" G	1617/104
	3/4"	20	rubber	2750 l/min	F 1" G	M 3/4" G	1617/105
	3/4"	30	rubber	2700 l/min	F 1" G	M 3/4" G	1617/106
	1"	15	rubber	3000 l/min	F 1" G	M 1" G	1617/107
	1"	20	rubber	2950 l/min	F 1" G	M 1" G	1617/108

	Dimension	Length (m)	Hose	Flow	Inlet	Outlet	Item
Serie 637 Hydraulic motor operated	Without hose	-	-	3500 l/min	F 1" G	F 1" G	1637/100
	1/2"	60	rubber	660 l/min	F 1" G	M 1/2" G	1637/101
	1/2"	70	rubber	640 l/min	F 1" G	M 1/2" G	1637/102
	1/2"	80	rubber	620 l/min	F 1" G	M 1/2" G	1637/103
	1/2"	90	rubber	600 l/min	F 1" G	M 1/2" G	1637/104
	1/2"	100	rubber	580 l/min	F 1" G	M 1/2" G	1637/105
	3/4"	40	rubber	2650 l/min	F 1" G	M 3/4" G	1637/106
	3/4"	50	rubber	2600 l/min	F 1" G	M 3/4" G	1637/107
	3/4"	60	rubber	2550 l/min	F 1" G	M 3/4" G	1637/108
	1"	30	rubber	2900 l/min	F 1" G	M 1" G	1637/109
	1"	40	rubber	2850 l/min	F 1" G	M 1" G	1637/110

	Dimension	Length (m)	Hose	Flow	Inlet	Outlet	Item
Serie 618 Air motor operated	Without hose	-	-	3500 l/min	F 1" G	F 1" G	1618/100
	1/2"	30	rubber	720 l/min	F 1" G	M 1/2" G	1618/101
	1/2"	40	rubber	700 l/min	F 1" G	M 1/2" G	1618/102
	1/2"	50	rubber	680 l/min	F 1" G	M 1/2" G	1618/103
	3/4"	15	rubber	2800 l/min	F 1" G	M 3/4" G	1618/104
	3/4"	20	rubber	2750 l/min	F 1" G	M 3/4" G	1618/105
	3/4"	30	rubber	2700 l/min	F 1" G	M 3/4" G	1618/106
	1"	15	rubber	3000 l/min	F 1" G	M 1" G	1618/107
		1"	20	rubber	2950 l/min	F 1" G	M 1" G

	Dimension	Length (m)	Hose	Flow	Inlet	Outlet	Item	
Serie 638 Air motor operated	Without hose	-	-	3500 l/min	F 1" G	F 1" G	1638/100	
	1/2"	60	rubber	660 l/min	F 1" G	M 1/2" G	1638/101	
	1/2"	70	rubber	640 l/min	F 1" G	M 1/2" G	1638/102	
	1/2"	80	rubber	620 l/min	F 1" G	M 1/2" G	1638/103	
	1/2"	90	rubber	600 l/min	F 1" G	M 1/2" G	1638/104	
	1/2"	100	rubber	580 l/min	F 1" G	M 1/2" G	1638/105	
	3/4"	40	rubber	2650 l/min	F 1" G	M 3/4" G	1638/106	
	3/4"	50	rubber	2600 l/min	F 1" G	M 3/4" G	1638/107	
	3/4"	60	rubber	2550 l/min	F 1" G	M 3/4" G	1638/108	
	1"	30	rubber	2900 l/min	F 1" G	M 1" G	1638/109	
		1"	40	rubber	2850 l/min	F 1" G	M 1" G	1638/110

Industrial Series

motor operated
Water - Hot water max. 130°C
400 bar

Swivel: St. steel AISI 304
Seals: Viton
Hose: Black synthetic rubber

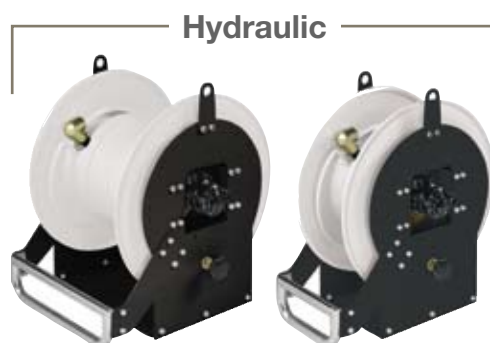

S. 637

S. 617

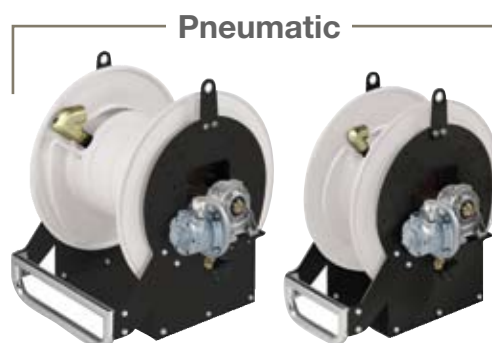

S. 638

S. 618

	Dimension	Length (m)	Hose	Flow	Inlet	Outlet	Item
Serie 617 Hydraulic motor operated	Without hose	-	-	140 l/min	F 1" G	F 1" G	I617/200
	1/2"	30	rubber	40 l/min	F 1" G	M 1/2" G	I617/201
	1/2"	40	rubber	37 l/min	F 1" G	M 1/2" G	I617/202
	1/2"	50	rubber	32 l/min	F 1" G	M 1/2" G	I617/203
	3/4"	15	rubber	100 l/min	F 1" G	M 3/4" G	I617/204
	3/4"	20	rubber	95 l/min	F 1" G	M 3/4" G	I617/205
	3/4"	30	rubber	90 l/min	F 1" G	M 3/4" G	I617/206
	1"	15	rubber	115 l/min	F 1" G	M 1" G	I617/207
	1"	20	rubber	110 l/min	F 1" G	M 1" G	I617/208

	Dimension	Length (m)	Hose	Flow	Inlet	Outlet	Item
Serie 637 Hydraulic motor operated	Without hose	-	-	140 l/min	F 1" G	F 1" G	I637/200
	1/2"	60	rubber	30 l/min	F 1" G	M 1/2" G	I637/201
	1/2"	70	rubber	27 l/min	F 1" G	M 1/2" G	I637/202
	1/2"	80	rubber	24 l/min	F 1" G	M 1/2" G	I637/203
	1/2"	90	rubber	21 l/min	F 1" G	M 1/2" G	I637/204
	1/2"	100	rubber	20 l/min	F 1" G	M 1/2" G	I637/205
	3/4"	40	rubber	87 l/min	F 1" G	M 3/4" G	I637/206
	3/4"	50	rubber	85 l/min	F 1" G	M 3/4" G	I637/207
	3/4"	60	rubber	82 l/min	F 1" G	M 3/4" G	I637/208
	1"	30	rubber	105 l/min	F 1" G	M 1" G	I637/209
1"	40	rubber	100 l/min	F 1" G	M 1" G	I637/210	

	Dimension	Length (m)	Hose	Flow	Inlet	Outlet	Item
Serie 618 Air motor operated	Without hose	-	-	140 l/min	F 1" G	F 1" G	I618/200
	1/2"	30	rubber	40 l/min	F 1" G	M 1/2" G	I618/201
	1/2"	40	rubber	37 l/min	F 1" G	M 1/2" G	I618/202
	1/2"	50	rubber	32 l/min	F 1" G	M 1/2" G	I618/203
	3/4"	15	rubber	100 l/min	F 1" G	M 3/4" G	I618/204
	3/4"	20	rubber	95 l/min	F 1" G	M 3/4" G	I618/205
	3/4"	30	rubber	90 l/min	F 1" G	M 3/4" G	I618/206
	1"	15	rubber	115 l/min	F 1" G	M 1" G	I618/207
	1"	20	rubber	110 l/min	F 1" G	M 1" G	I618/208

	Dimension	Length (m)	Hose	Flow	Inlet	Outlet	Item
Serie 638 Air motor operated	Without hose	-	-	140 l/min	F 1" G	F 1" G	I638/200
	1/2"	60	rubber	30 l/min	F 1" G	M 1/2" G	I638/201
	1/2"	70	rubber	27 l/min	F 1" G	M 1/2" G	I638/202
	1/2"	80	rubber	24 l/min	F 1" G	M 1/2" G	I638/203
	1/2"	90	rubber	21 l/min	F 1" G	M 1/2" G	I638/204
	1/2"	100	rubber	20 l/min	F 1" G	M 1/2" G	I638/205
	3/4"	40	rubber	87 l/min	F 1" G	M 3/4" G	I638/206
	3/4"	50	rubber	85 l/min	F 1" G	M 3/4" G	I638/207
	3/4"	60	rubber	82 l/min	F 1" G	M 3/4" G	I638/208
	1"	30	rubber	105 l/min	F 1" G	M 1" G	I638/209
	1"	40	rubber	100 l/min	F 1" G	M 1" G	I638/210

Industrial Series

motor operated
Oil - Antifreeze and allied products
150 bar

Svirvel: Steel
Pakning: Polyurethane
Slange: Black synthetic rubber

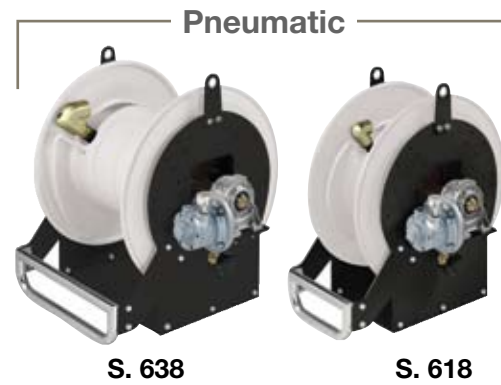
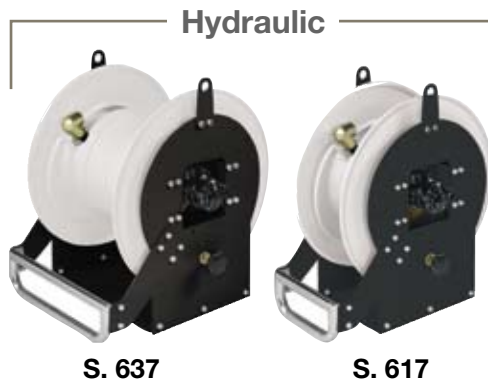

	Dimension	Length (m)	Hose	Flow	Inlet	Outlet	Item
Serie 617 Hydraulic motor operated	Without hose	-	-	50 l/min	F 1" G	F 1" G	1617/400
	1/2"	30	rubber	8 l/min	F 1" G	M 1/2" G	1617/401
	1/2"	40	rubber	7 l/min	F 1" G	M 1/2" G	1617/402
	1/2"	50	rubber	6 l/min	F 1" G	M 1/2" G	1617/403
	3/4"	15	rubber	30 l/min	F 1" G	M 3/4" G	1617/404
	3/4"	20	rubber	26 l/min	F 1" G	M 3/4" G	1617/405
	3/4"	30	rubber	22 l/min	F 1" G	M 3/4" G	1617/406
	1"	15	rubber	35 l/min	F 1" G	M 1" G	1617/407
	1"	20	rubber	32 l/min	F 1" G	M 1" G	1617/408

	Dimension	Length (m)	Hose	Flow	Inlet	Outlet	Item
Serie 637 Hydraulic motor operated	Without hose	-	-	50 l/min	F 1" G	F 1" G	1637/400
	1/2"	60	rubber	6 l/min	F 1" G	M 1/2" G	1637/401
	1/2"	70	rubber	5 l/min	F 1" G	M 1/2" G	1637/402
	1/2"	80	rubber	5 l/min	F 1" G	M 1/2" G	1637/403
	1/2"	90	rubber	4 l/min	F 1" G	M 1/2" G	1637/404
	1/2"	100	rubber	4 l/min	F 1" G	M 1/2" G	1637/405
	3/4"	40	rubber	20 l/min	F 1" G	M 3/4" G	1637/406
	3/4"	50	rubber	18 l/min	F 1" G	M 3/4" G	1637/407
	3/4"	60	rubber	17 l/min	F 1" G	M 3/4" G	1637/408
	1"	30	rubber	30 l/min	F 1" G	M 1" G	1637/409
	1"	40	rubber	27 l/min	F 1" G	M 1" G	1637/410

	Dimension	Length (m)	Hose	Flow	Inlet	Outlet	Item
Serie 618 Air motor operated	Without hose	-	-	50 l/min	F 1" G	F 1" G	1618/400
	1/2"	30	rubber	8 l/min	F 1" G	M 1/2" G	1618/401
	1/2"	40	rubber	7 l/min	F 1" G	M 1/2" G	1618/402
	1/2"	50	rubber	6 l/min	F 1" G	M 1/2" G	1618/403
	3/4"	15	rubber	30 l/min	F 1" G	M 3/4" G	1618/404
	3/4"	20	rubber	26 l/min	F 1" G	M 3/4" G	1618/405
	3/4"	30	rubber	22 l/min	F 1" G	M 3/4" G	1618/406
	1"	15	rubber	35 l/min	F 1" G	M 1" G	1618/407
	1"	20	rubber	32 l/min	F 1" G	M 1" G	1618/408

	Dimension	Length (m)	Hose	Flow	Inlet	Outlet	Item	
Serie 638 Air motor operated	Without hose	-	-	50 l/min	F 1" G	F 1" G	1638/400	
	1/2"	60	rubber	6 l/min	F 1" G	M 1/2" G	1638/401	
	1/2"	70	rubber	5 l/min	F 1" G	M 1/2" G	1638/402	
	1/2"	80	rubber	5 l/min	F 1" G	M 1/2" G	1638/403	
	1/2"	90	rubber	4 l/min	F 1" G	M 1/2" G	1638/404	
	1/2"	100	rubber	4 l/min	F 1" G	M 1/2" G	1638/405	
	3/4"	40	rubber	20 l/min	F 1" G	M 3/4" G	1638/406	
	3/4"	50	rubber	18 l/min	F 1" G	M 3/4" G	1638/407	
	3/4"	60	rubber	17 l/min	F 1" G	M 3/4" G	1638/408	
	1"	30	rubber	30 l/min	F 1" G	M 1" G	1638/409	
		1"	40	rubber	27 l/min	F 1" G	M 1" G	1638/410

Industrial Series

motor operated
Grease
400 bar

Swivel: Steel
Seals: Polyurethane
Hose: Black synthetic rubber

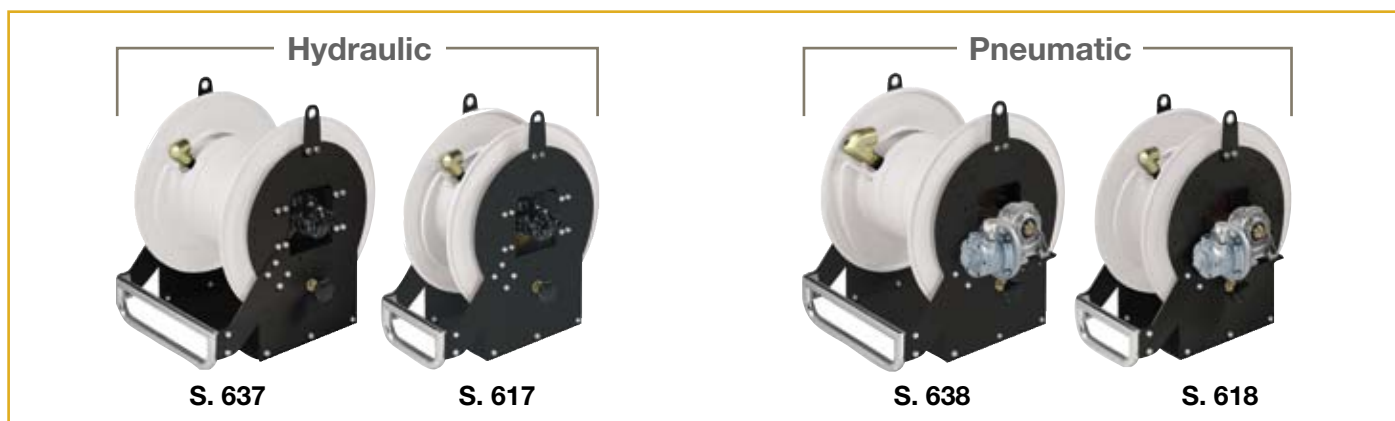

	Dimension	Length (m)	Hose	Flow	Inlet	Outlet	Item
Serie 617 Hydraulic motor operated	Without hose	-	-	4000 g/min	F 1" G	F 1" G	I617/500
	1/2"	30	rubber	800 g/min	F 1/2" G	M 1/2" G	I617/501
	1/2"	40	rubber	750 g/min	F 1/2" G	M 1/2" G	I617/502
	1/2"	50	rubber	700 g/min	F 1/2" G	M 1/2" G	I617/503

	Dimension	Length (m)	Hose	Flow	Inlet	Outlet	Item
Serie 637 Hydraulic motor operated	Without hose	-	-	4000 g/min	F 1" G	F 1" G	I637/500
	1/2"	60	rubber	650 g/min	F 1/2" G	M 1/2" G	I637/501
	1/2"	70	rubber	600 g/min	F 1/2" G	M 1/2" G	I637/502
	1/2"	80	rubber	550 g/min	F 1/2" G	M 1/2" G	I637/503
	1/2"	90	rubber	560 g/min	F 1/2" G	M 1/2" G	I637/504
1/2"	100	rubber	450 g/min	F 1/2" G	M 1/2" G	I637/505	

	Dimension	Length (m)	Hose	Flow	Inlet	Outlet	Item
Serie 618 Air motor operated	Without hose	-	-	4000 g/min	F 1" G	F 1" G	I618/500
	1/2"	30	rubber	800 g/min	F 1/2" G	M 1/2" G	I618/501
	1/2"	40	rubber	750 g/min	F 1/2" G	M 1/2" G	I618/502
	1/2"	50	rubber	700 g/min	F 1/2" G	M 1/2" G	I618/503

	Dimension	Length (m)	Hose	Flow	Inlet	Outlet	Item
Serie 638 Hydraulic motor operated	Without hose	-	-	4000 g/min	F 1" G	F 1" G	I638/500
	1/2"	60	rubber	650 g/min	F 1/2" G	M 1/2" G	I638/501
	1/2"	70	rubber	600 g/min	F 1/2" G	M 1/2" G	I638/502
	1/2"	80	rubber	550 g/min	F 1/2" G	M 1/2" G	I638/503
	1/2"	90	rubber	560 g/min	F 1/2" G	M 1/2" G	I638/504
1/2"	100	rubber	450 g/min	F 1/2" G	M 1/2" G	I638/505	

Industrial Series

motor operated
Diesel fuel and kerosene
10 bar

Svirvel: Steel - Brass
Pakning: Viton
Slange: Antistatic black synthetic rubber

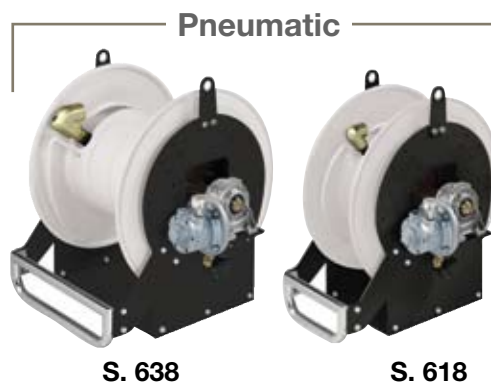
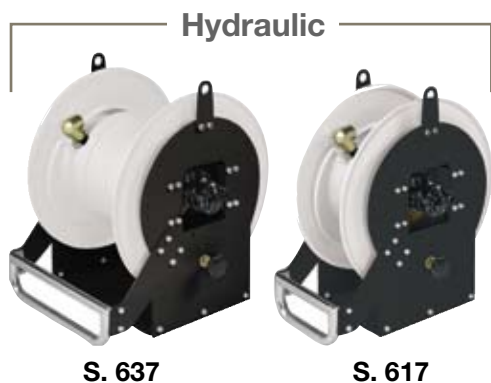



	Dimension	Length (m)	Hose	Flow	Inlet	Outlet	Item
Serie 617 Hydraulic motor operated	Without hose	-	-	300 l/min	F 1.½" G	F 1.½" G	I617/600
	3/4"	15	rubber	100 l/min	F 1.½" G	M 3/4" G	I617/601
	3/4"	20	rubber	95 l/min	F 1.½" G	M 3/4" G	I617/602
	3/4"	30	rubber	90 l/min	F 1.½" G	M 3/4" G	I617/603
	1"	15	rubber	125 l/min	F 1.½" G	M 1" G	I617/604
	1"	20	rubber	120 l/min	F 1.½" G	M 1" G	I617/605
	1.¼"	15	rubber	200 l/min	F 1.½" G	M 1.½" G	I617/606
	1.½"	10	rubber	250 l/min	F 1.½" G	M 1.½" G	I617/607



	Dimension	Length (m)	Hose	Flow	Inlet	Outlet	Item
Serie 637 Hydraulic motor operated	Without hose	-	-	300 l/min	F 1.½" G	F 1.½" G	I637/600
	3/4"	40	rubber	87 l/min	F 1.½" G	M 3/4" G	I637/601
	3/4"	50	rubber	85 l/min	F 1.½" G	M 3/4" G	I637/602
	3/4"	60	rubber	82 l/min	F 1.½" G	M 3/4" G	I637/603
	1"	30	rubber	115 l/min	F 1.½" G	M 1" G	I637/604
	1"	40	rubber	110 l/min	F 1.½" G	M 1" G	I637/605
	1.¼"	20	rubber	185 l/min	F 1.½" G	M 1.¼" G	I637/606
	1.¼"	25	rubber	175 l/min	F 1.½" G	M 1.¼" G	I637/607
	1.¼"	30	rubber	165 l/min	F 1.½" G	M 1.¼" G	I637/608
	1.½"	15	rubber	230 l/min	F 1.½" G	M 1.½" G	I637/609
1.½"	20	rubber	220 l/min	F 1.½" G	M 1.½" G	I637/610	



	Dimension	Length (m)	Hose	Flow	Inlet	Outlet	Item
Serie 618 Air motor operated	Without hose	-	-	140 l/min	F 1" G	F 1" G	I618/100
	3/4"	15	rubber	100 l/min	F 1" G	M 3/4" G	I618/601
	3/4"	20	rubber	95 l/min	F 1" G	M 3/4" G	I618/602
	3/4"	30	rubber	90 l/min	F 1" G	M 3/4" G	I618/603
	1"	15	rubber	115 l/min	F 1" G	M 1" G	I618/604
	1"	20	rubber	110 l/min	F 1" G	M 1" G	I618/605



	Dimension	Length (m)	Hose	Flow	Inlet	Outlet	Item
Serie 638 Air motor operated	Without hose	-	-	140 l/min	F 1" G	F 1" G	I638/100
	3/4"	40	rubber	87 l/min	F 1" G	M 3/4" G	I638/601
	3/4"	50	rubber	85 l/min	F 1" G	M 3/4" G	I638/602
	3/4"	60	rubber	82 l/min	F 1" G	M 3/4" G	I638/603
	1"	30	rubber	105 l/min	F 1" G	M 1" G	I638/604
	1"	40	rubber	100 l/min	F 1" G	M 1" G	I638/605



SERIES INDUSTRIAL (OPEN AND CLOSED)



 Ø 12 mm	max 16 m	Series 270 inlet 3/8"
 Ø 14 mm	max 14 m	
 Ø 16 mm	max 10 m	



 Ø 12 mm	max 18 m	Series 300 inlet 3/8"-1/2"
 Ø 14 mm	max 16 m	
 Ø 16 mm	max 12 m	



 Ø 12 mm	max 22 m	Series 350 inlet 3/8"-1/2"
 Ø 14 mm	max 20 m	
 Ø 16 mm	max 18 m	



 Ø 17 mm	max 21 m	Series 440 Series 430 inlet 1/2"
 Ø 19,5 mm	max 16 m	
 Ø 22 mm	max 14 m	

 Ø 18,5 mm	max 28 m	Series 530 inlet 1/2"
 Ø 20 mm	max 26 m	
 Ø 22 mm	max 24 m	



 Ø 17 mm	max 30 m	Series 540 inlet 1/2"
 Ø 19,5 mm	max 30 m	
 Ø 22 mm	max 30 m	



 Ø 28 mm	max 22 m	Series 540 inlet 1"
 Ø 34 mm	max 17 m	



 Ø 17 mm	max 50 m	Series 560 inlet 1/2"
 Ø 19,5 mm	max 60 m	
 Ø 22 mm	max 60 m	

 Ø 30 mm	max 40 m	Series 560 inlet 1"
 Ø 35 mm	max 30 m	



SERIES INDUSTRIAL FOR OXYGEN / ACETYLENE - DUAL HOSES



 Ø 13 +13 mm	max 13 m	Series 430 inlet 3/8"
 Ø 15 +15 mm	max 12 m	
 Ø 16 +16 mm	max 10 m	



 Ø 13 +13 mm	max 22 m	Series 530 inlet 3/8"
 Ø 15 +15 mm	max 20 m	
 Ø 16 +16 mm	max 15 m	



 Ø 13 +13 mm	max 22 m	Series 540 inlet 3/8"
 Ø 15 +15 mm	max 20 m	
 Ø 16 +16 mm	max 15 m	



SERIES INDUSTRIAL FOR LPG, METHANE

 Ø 15 mm	max 14 m	Series 300 inlet 3/8"
 Ø 17 mm	max 12 m	



 Ø 15 mm	max 18 m	Series 350 inlet 3/8"
 Ø 17 mm	max 17 m	





 Ø 15 mm	max 20 m	Series 430 inlet 3/8"
 Ø 17 mm	max 18 m	



 Ø 15 mm	max 28 m	Series 530 inlet 3/8"
 Ø 17 mm	max 27 m	





 Ø 15 mm	max 30 m	Series 540 inlet 3/8"
 Ø 17 mm	max 30 m	

SERIES INDUSTRIAL POWERED











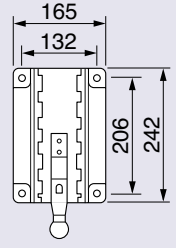

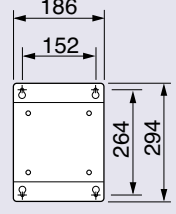
 Ø 20 mm	max 50 m	Series 617 Series 618 inlet 1"
 Ø 27 mm	max 30 m	
 Ø 35 mm	max 20 m	

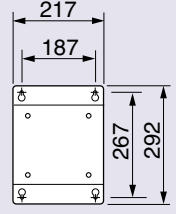
 Ø 27 mm	max 30 m	Series 617 inlet 1.1/2"
 Ø 35 mm	max 20 m	
 Ø 44 mm	max 15 m	
 Ø 50 mm	max 10 m	

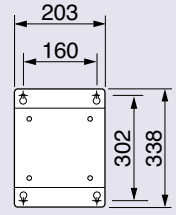
 Ø 20 mm	max 100 m	Series 637 Series 638 inlet 1"
 Ø 27 mm	max 60 m	
 Ø 35 mm	max 40 m	

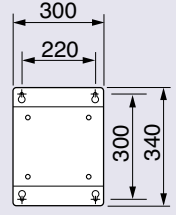
 Ø 27 mm	max 60 m	Series 637 inlet 1.1/2"
 Ø 35 mm	max 40 m	
 Ø 44 mm	max 30 m	
 Ø 50 mm	max 20 m	

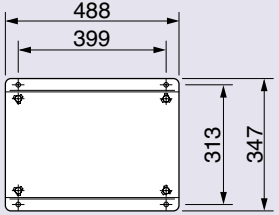
Fixed and Swivelling brackets

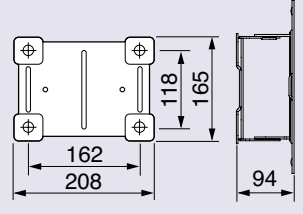
	<p>Series Wall bracket with bayonet hooking Series 260:</p>	<p>Item I260/01</p>	
	<p>Fixed wall bracket for fixed hose reels Series 270-300-350-430 Fixed wall bracket for fixed hose reels Series 270-300-350-430 AISI304</p>	<p>I430/01 I430/02</p>	
	<p>Fixed wall bracket for fixed hose reels Series 440</p>	<p>I440/01</p>	
	<p>Fixed wall bracket for fixed hose reels Series 530 Fixed wall bracket for fixed hose reels Series 530 AISI304</p>	<p>I530/01 I530/02</p>	
	<p>Fixed wall bracket for fixed hose reels Series 540 Fixed wall bracket for fixed hose reels Series 540 AISI 304</p>	<p>I540/01 I540/02</p>	
	<p>Fixed wall bracket for fixed hose reels Series 560 Fixed wall bracket for fixed hose reels Series 560 AISI304</p>	<p>I560/01 I560/02</p>	
	<p>Swivelling wall bracket for fixed hose reels Series 270-300-350-430 Swivelling wall bracket for fixed hose reels Series 270-300-350-430 AISI304</p>	<p>I430/05 I430/06</p>	

Fixed and Swivelling brackets



Series
Swivelling wall bracket for fixed hose reels Series 440

Item
I440/05

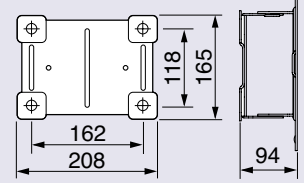

Swivelling wall bracket for fixed hose reels Series 530
Swivelling wall bracket for fixed hose reels Series 530 AISI 304

I530/05
I530/06

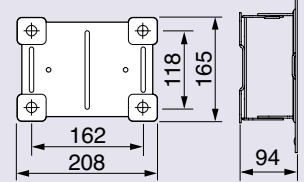

Swivelling wall bracket for fixed hose reels Series 540
Swivelling wall bracket for fixed hose reels Series 540 AISI 304

I540/05
I540/06

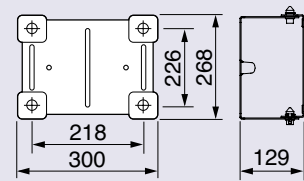

The solid and compact bracket is provided with four slotted mounting holes for easy and safe installation. Using the template supplied with the hose reel it's easier to mark plugs holes for hose reel fixing.

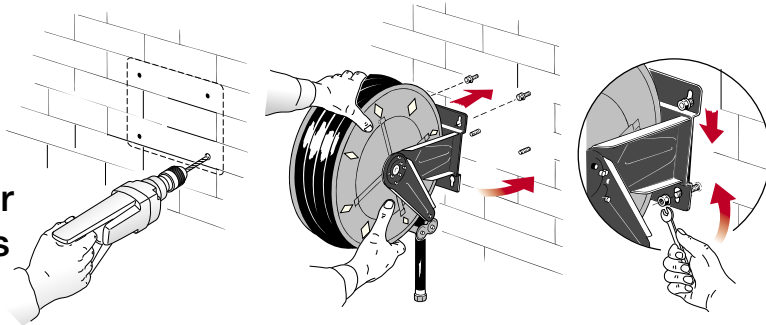

On request an additional bracket for a quick installation and disassembly is available. Furthermore this bracket allows installing several hose reels in series.

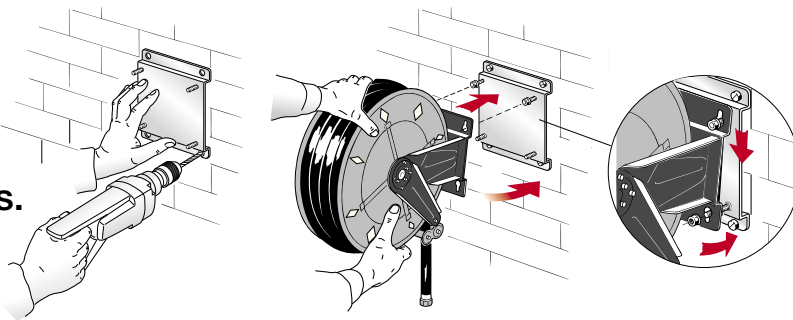

On request a swivelling bracket to make the reel turning 40° to the right and 40° to the left is available.

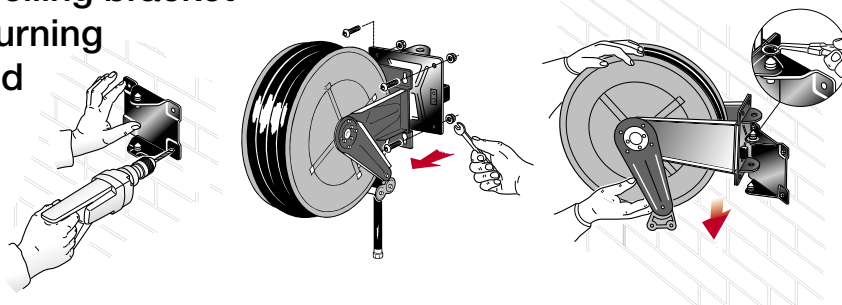

Technical features

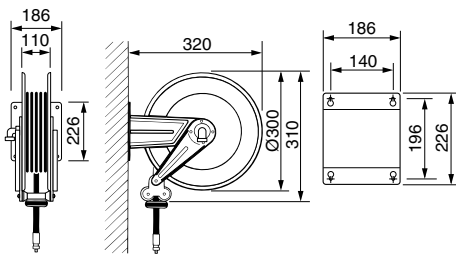

Series 270

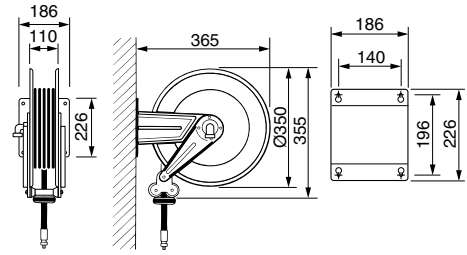

Series 300

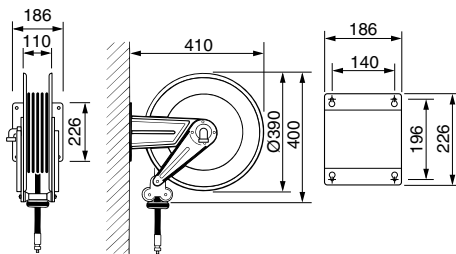

Series 350

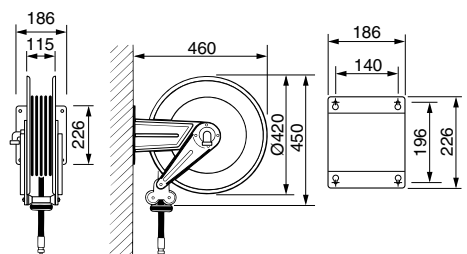

Series 430

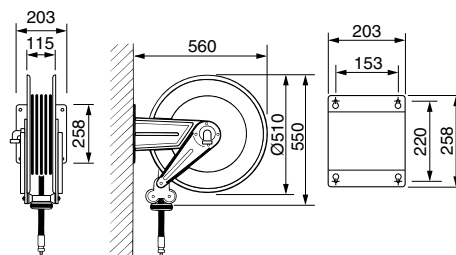

Series 530

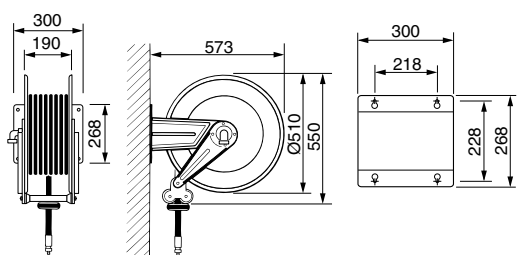

Series 540

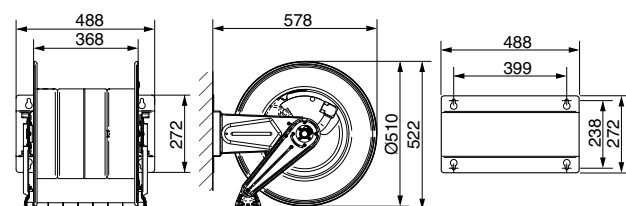

Series 560

Technical features

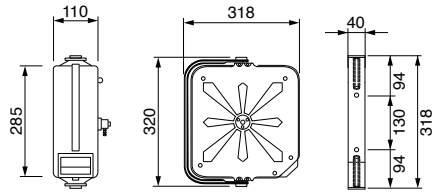

Series 260

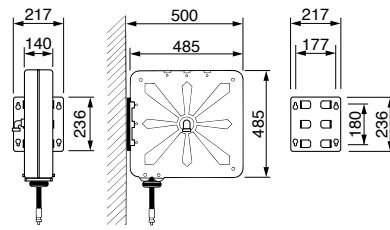

Series 440

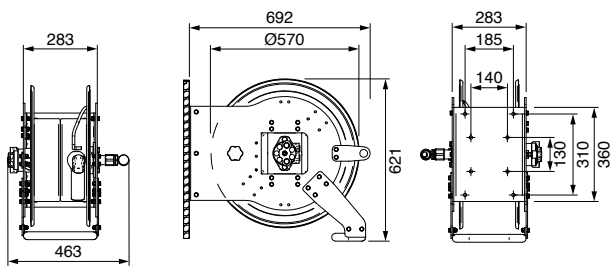

Series 617, inlet 1"

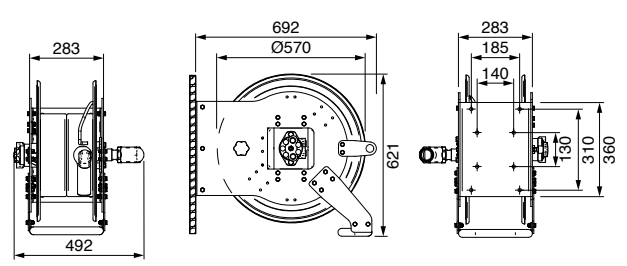

Series 617, inlet 1 1/2"

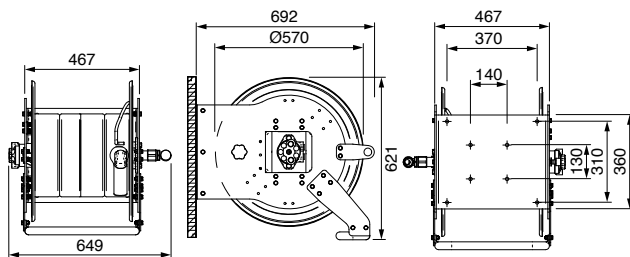

Series 637, inlet 1"

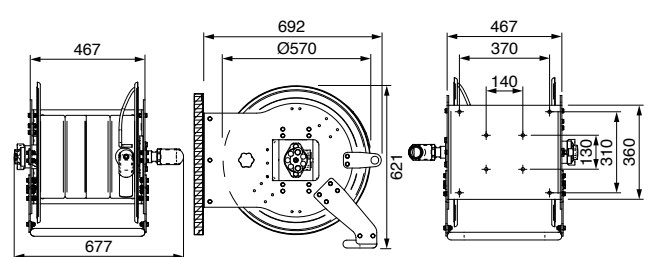

Series 637, inlet 1 1/2"

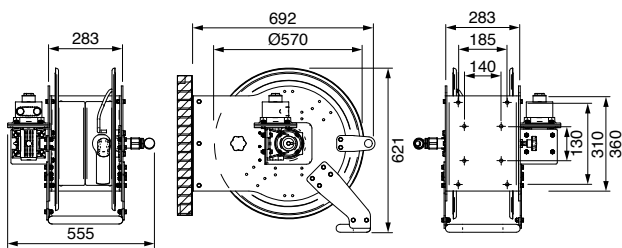

Series 618, inlet 1"

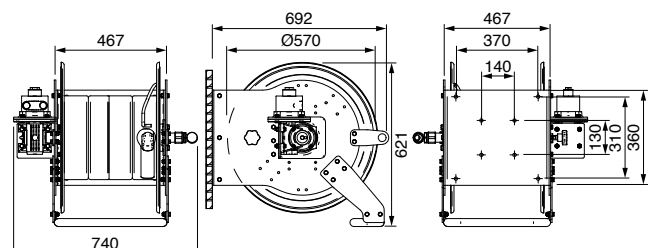

Series 638, inlet 1"



We are not accountable for any misprint, omission or technical changes.

We refer to our general terms of delivery.

Delivery time: On some industrial models the delivery time
can be 3-4 weeks from receipt of order.

Rectus Tema ApS

Langballe 8

8700 Horsens

Danmark

telefon +45 7564 6155

fax +45 7564 6255

info@rectustema.dk

www.rectustema.dk

